

5 LINES
6 COLLECTIONS

25 YEARS
OF WARRANTY

Doors and windows
VIK KING

**COMPOSITE
ENTRANCE DOORS**

2022
www.vikking.lv



WE FULFILL DREAMS ABOUT BEAUTIFUL AND FUNCTIONAL HOMES

Vikking is a family company with 30 years of tradition. We always adhere to the principle of business reliability.

Credibility and honesty as well as a dedication to manufacturing products of the highest standard have been our vectors during our history. This is confirmed by numerous certificates, awards and a constantly growing group of satisfied customers in over a dozen countries around the world.

We have created a proprietary technology of energy-saving composite doors with superior technical parameters and aesthetic values in comparison to traditional products.

LED lighting in the door leaf, an innovative PVC door frame with Real Wood decoration, a patented system of structural bonding of glazing with countless design and decoration options, and a unique combination in the on non-rebated on both sides version doors from the Ultimate line - this is just one example of the extensive range created by our R&D department. Satisfaction from a well-performed mission and continuous participation in the process of setting new trends is a priceless value for us.



CUSTOMIZED COMPOSITE DOORS AND REAL WOOD WINDOWS

The VIKKING brand is synonymous with customized joinery. Despite the global trend of product standardization, we are proud to be one of the few brands which offer tailor-made products. We design every composite door and Real Wood window taking into account the most sophisticated expectations so that you can enjoy a reliable product for decades.

We have combined advanced technology and innovative solutions with attention to every detail, so that each window and door stands out with precision, quality and optimal functionality, without any compromises in terms of durability and comfort of use characteristic of exclusive products.

PERFECTLY MATCHED

Share your dreams with us, choose from our extensive range of the highest quality door handles and other accessories – we will compose them with the utmost care. Your safety and comfort of use will be increased thanks to our advanced remote-control systems and SMART HOME integration installations.

INNOVATION AND DESIGN

The ULTIMATE door line – the leaf and frame connection is flush on both sides and the whole product is made of composite materials. This innovative solution allows to meet even the most non-standard needs. The wide range of solutions, sizes and fittings as well as the attractive appearance of hidden hinges ensure unique aesthetic values without any compromises in terms of quality and long-term maintenance-free durability. ULTIMATE doors are valued for their modern and elegant minimalism.

OPEN UP TO NEW POSSIBILITIES



25 YEARS OF WARRANTY

Because we offer you composite doors of the highest quality and durability, regardless of the statutory requirements for the protection of consumer rights – we provide an extended warranty for trouble-free operation.

This is an undeniable advantage of a composite door system that wood or metal cannot ensure.

Clear rules

The manufacturer's technical efficiency warranty is subject to:

- I - proper selection of doors and accessories adequate to the operating conditions,
- II - operation of the composite doors in accordance with their intended purpose,
- III - correct, warm fitting of doors by authorized fitters according to the manufacturer's instructions,
- IV - performing periodic inspections, adjustments and maintenance according to the manufacturer's guidelines,
- V - immediate reporting of defects to prevent further damage to the door,
- VI - use of the doors in an individual housing segment, for other applications a standard 3-year warranty applies.

The full content of the warranty provisions and instructions regarding quality acceptance, correct assembly, operation and maintenance are attached to each product in the language of the country of destination.

We provide warranty and post-warranty service.



DURABLE



SAFE



FUNCTIONAL

Composite door leaf and frame

25 years

PVC frames, hinges and lock catches

20 years

Varnish coatings, stained glazing and seals

5 years

Strip locks and technical efficiency of other door components

3 years

Brand - a guarantee of reliable products

VIKKING composite doors guarantee the highest quality for generations.

YOU DON'T HAVE TO ACCEPT COMPROMISES!

Not all door manufacturers provide both the highest aesthetic values and the best home protection parameters.

We have created innovative composite doors from scratch to do just that – to meet even the most demanding expectations.

Advanced technology and innovative solutions allow us to produce the doors of your dreams without the slightest compromise in quality and durability! No other door has so many advantages, without the disadvantages and limitations of traditional technologies. Composite doors are resistant to adverse weather conditions, they do not absorb moisture, do not corrode and maintain the highest quality for decades.

VIKKING SPECIALIZES IN THE FULFILMENT OF EVEN THE MOST CUSTOMIZED ORDERS.

Unleash your creativity – start by changing your doors.

Choose your style, any combination of colours and door surface textures. Choose the most convenient door handles and the most beautiful stained glass, and we will handle the rest with the utmost care.

To make it easier for our customers to select products, we have divided our doors according to lines, collections, models and accessories.

Share your wishes with us and our designers will do their best to implement even the most imaginative concepts. After all, our motto is: "What is impossible for others, is standard for us"





NEW THE ULTIMATE LINE

▶ **INNOVATIVE
DOOR CONSTRUCTION**

▶ **DOOR LEAF THICKNESS 90 MM**

▶ **COMPOSITE DOOR FRAME**

▶ **FLUSH ON BOTH SIDES**

▶ **HIDDEN HINGES**

MORE INFORMATION
ON PAGE 15

Feel the power of technology that protects your safety. The most solid construction thanks to advanced composite technology and unique solutions. Components from reliable suppliers ensure the highest quality of composite doors.

NEW PRODUCTS IN 2022

New door pulls

New collections of door handles as well as other accessories can be found on pages 62-64



Coating with the GALAXY, PEARL or SAND effect

The GALAXY, PEARL and SAND powder coating can be used on SMOOTH surfaces in all RAL colours.



The Online Door Configurator

Configure your dream door without leaving your home!

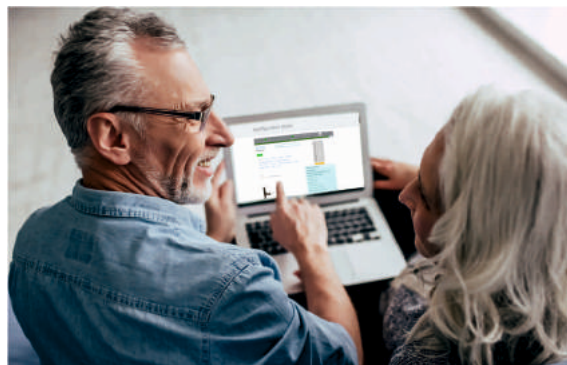

ARCTIC ULTRA line

The new ARCTIC ULTRA line with a 90 mm door leaf joined with a 85 mm PVC six-chamber door frame has a spectacular Ud heat transfer coefficient from 0,51 W/m²K. Details on page 14.



VINTAGE collection

Discover our range of doors from the Vintage collection with beautiful rustic slats. More details on page 20.



A NEW LOOK FOR YOUR DOOR

INSPIRATION FOR CUSTOMERS LOOKING FOR NON-STANDARD SOLUTIONS

A portal is a permanent door installation in a side layout, top layout, or any other configuration, and is an attractive architectural component. Portals, similarly to doors, are made of composite materials. That is why they are equally warm, durable and resistant to all weather conditions. A wide range of sizes and decorative solutions ensure freedom of choice in arranging the entrance to your home.

Available only in the ULTIMATE composite door line.



COMFORT OF USE AND FUNCTIONALITY

SMART HOME – DOORS WITH SMART CONTROL

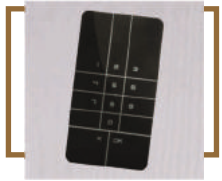

Is it possible to replace keys with a better solution? Of course, you can use a smartphone, keyboard, fingerprint reader, card or key ring.

FUNCTIONAL FITTINGS



A remote control, automatically locking multi-point lock, invisible closing device, electronic peephole, closing sensor – these are just a few of many innovative solutions for your comfort and security.

REINFORCED WITH FIBERGLASS



Thanks to the use of fiberglass technology, composite doors are impenetrable for intruders, they do not require tedious and frequent maintenance, and their unsurpassed durability ensures security for many years.

DURABLE AND RESISTANT TO DAMAGE



Composite doors are resistant to moisture and extreme weather conditions. The door leafs do not deform and are resistant to mechanical damage to a much greater extent than doors made of traditional materials. We guarantee their technical durability for decades.

EXCELLENT PARAMETERS AND PROTECTION

THE WARMEST DOORS ON THE MARKET

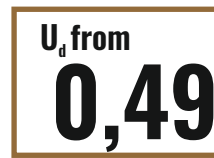

Composite doors, unlike traditional metal or aluminum doors are made only of materials which protect against the loss of valuable energy. And this means measurable savings on heating the house in winter. All our composite door lines exceed the requirements of passive housing.

OUR DOORS DO NOT REQUIRE OVERHANGS



Composite doors, unlike metal and wooden doors, do not corrode, and are resistant to moisture and harmful UV radiation. As the only ones in their class, they do not require full overhang or maintaining minimum distances from heating devices inside the house.

WARM INTERCASE FRAMES IN GLAZING



All glazing in our composite doors have super warm frames between panes. The warm frame technology significantly improves the energy efficiency, soundproofing and lifetime of glass units.

SECURE



The RC2 anti-burglary class guarantees a sense of security. Composite doors are equipped with a system of multi-point locks and anti-theft bolts, which increases the level of security and protects against burglary.

CUSTOMIZED PRODUCTS

ALL THE COLORS OF THE WORLD

Composite doors are varnished in all colours from the RAL palette, and can include special effects and wood-like decors. You can choose any configuration of colours you desire.



HIDDEN HINGES

The ULTIMATE line sets new trends, and their functionality is increased by hidden hinges that allow the door leaf to open 180°.



LED LIGHTING

LED lighting in glazing is an attractive and functional alternative to traditional lighting of the entrance. Vikking is one of the first brands to use integrated LED lighting in doors, including the threshold.



ILLUMINATED DOOR LEAF

A gentle glow coming from under the composite wing provides soft illumination of the entrance area.



COLOURS WITH PEARL EFFECT

Our proprietary varnishing technology allows to apply the pearl effect on any colour from the RAL palette or wood-like decors.

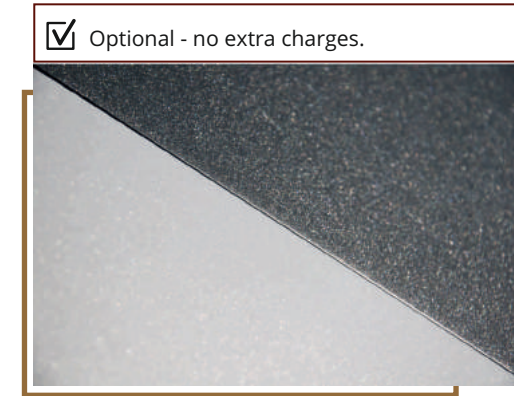

INDIVIDUAL DECORATIONS

Choose any design, content, and decorations for your house number and we will make your ideas come to life.



The CRYSTAL collection

Timeless beauty in glass



In the CRYSTAL door collection, the glazing unit is made using so-called step technology. The outer pane of the glazing, decorated with a special ceramic coating, has a larger surface area than the inner pane. This gives a unique visual effect.

The Crystal 01 model is available only in the ARCTIC PLUS line in the following dimensions:

- 1020 x 2080
- 1070 x 2130

The Desing 3D application



Composite door leaf, 65 mm thick, from the ARCTIC line with an additional 43 mm thick composite overlay.

The 3D door leaf is only available in the ARCTIC line, in the inward-opening version.

External dimensions of the door from this collection:

- 970 x 2030
- 970 x 2130
- 1070 x 2030
- 1070 x 2130

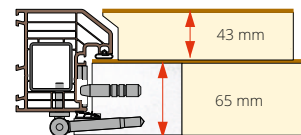

Glazing in Priva-Lite technology

Electronically controlled glass with variable translucency. After supplying with low-voltage current, the liquid crystal particles in the LC foil adopt a regular system, making the glass transparent.



Protect your privacy when you want and how you want

CUSTOMIZED PRODUCTS

XXL DOORS

The possibility of making XXL doors in a max. dimension of 1150 mm x 2450 mm.

Do you need something bigger? Choose a door with lights or a portal.



SIDE AND UPPER LIGHTING

Only in the composite door system

offer the possibility of using sidelights and transom lights in any configuration, size and shape.

Check the lighting configuration options on page 71



U ULTIMATE

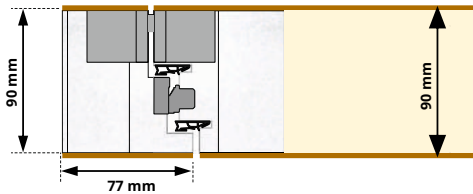

The world's first, unique combination of a door leaf with a composite frame has properties that are unavailable in traditional solutions. The whole product is made of composite materials. Both sides are flush with the frame, stable, ultra-warm, in an unlimited catalog of solutions. Only available in the ULTIMATE line.

AU ARCTIC ULTRA

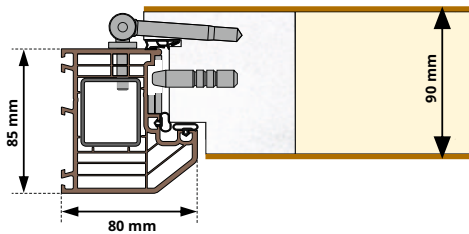

Innovative six-chamber PVC A-class door frame with Real Wood or smooth surface. PVC profiles are resistant to moisture, perfectly insulate from cold and require no maintenance. The system of extensions, connectors and clamps provides the possibility for any frame configuration.

A solid multi-layer construction ensures stability of the door leaf and anti-burglary protection. The door leaf cladding is made of the highest quality fiberglass reinforced composite panels, resistant to scratches and damage.

The highest quality varnishes in any RAL colour, or in one of many wood-like decors combined with the total moisture resistance of composite doors make them much more resistant than traditional doors.

AP ARCTIC PLUS

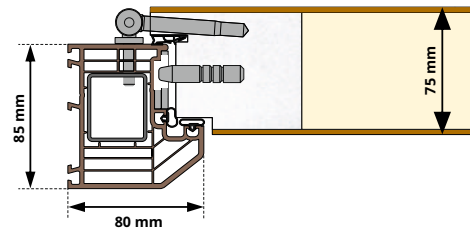

A ARCTIC

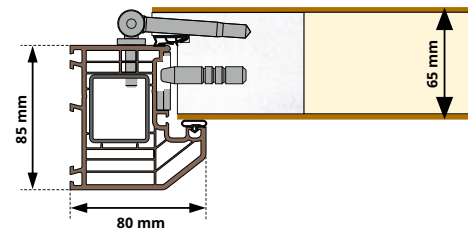

A composite door leaf has a specially reinforced structure, preventing deformation even in the most difficult weather conditions. It is resistant to moisture and mechanical damage. Only composite door leaves consistently maintain the highest quality for decades without the need for maintenance and varnishing.

The waterproof composite frame protects the inside of the door leaf against moisture, and the CFC-free PU foam insulation with specially designed parameters for the composite door system provides excellent protection against heat loss.

Our silicone seals specially designed for composite doors guarantee the highest protection against heat loss around the entire perimeter and provide high closing comfort.

T TOP

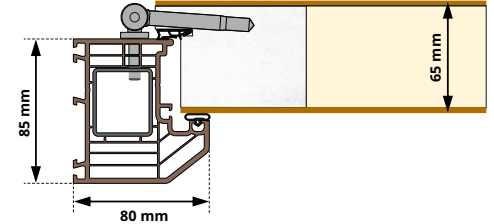

U ULTIMATE

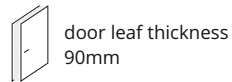

door leaf thickness
90mm



thermal insulation
 U_d from 0,49 W/m²K



Rc2 anti-burglary
class

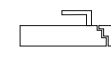

flush on
both sides



do not require
an overhang



Hidden hinges



Door leaf and composite frame
thickness 90 mm



Anti-burglary bolts



Low aluminum threshold
with a thermal insulation profile
under the threshold



Frame strip

STANDARD ACCESSORIES

Standard fittings for complete external doors from the ULTIMATE line:

- **90 mm** thick composite flush door leaf with a dedicated Real Wood composite door frame, optionally with a *SMOOTH* surface, at extra charge; optionally at extra charge: in any combination of both surfaces;
 - 90x77 mm composite door frame with the same surface for the door leaf;
 - combination: both sides flush with the frame;
 - complete doors varnished with the highest quality varnish in the RAL palette or in one of several wood-like decors, optionally without extra charge with the *pearl* or *Galaxy effect*, optional at extra charge: varnishing in several configured colours
 - Low aluminum threshold with a thermal insulation profile under the threshold; optional with extra charge with a system of warm sub-threshold profiles;
 - three hidden hinges, 3D adjustable;
 - anti-burglary bolt system;
 - three-point anti-theft strip lock bolted with a handle, cylinder lock, or automatically;
 - frame strip, adjustable;
 - double, perimeter sealing system;
 - wind-stop seal – an additional seal in the door sill;
 - version with glazing: four-pane glazing with a warm frame system
- The price of the door includes one of many patterns of decorations from groups "0", "I" or "II" optionally at extra charge: decorated stained glazing from group "III";

The price of the door includes a set of dedicated installation consoles.

AU ARCTIC ULTRA

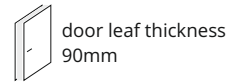

door leaf thickness
90mm



thermal insulation
 U_d from 0,51 W/m²K



Rc2 anti-burglary
class



rebated
system



do not require
an overhang



Multi-point anti-burglary
strip locks

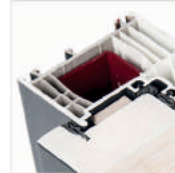

Six-chamber
PVC door frame



Four 3D adjustable
hinges

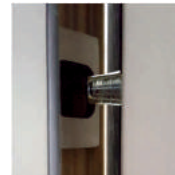

Anti-burglary bolts



Four-pane glazing
with a warm frame system



Silicone seals



Low aluminium threshold
with a thermal break



Wind-stop seal

STANDARD ACCESSORIES

Standard fittings for complete external doors from the ARCTIC ULTRA line:

- **90 mm** thick composite door leaf with wood-like Real Wood surface structure on both sides
optionally with a SMOOTH surface, at extra charge;
optionally at extra charge: in any combination of both surfaces;
- PVC 85 mm door frame, six-chamber, class A Plus with identical surface for the leaf;
optionally at extra charge: meranti door frame
- complete doors varnished with the highest quality varnish in the RAL palette or in one of several wood-like decors,
optionally without extra charge with the pearl or Galaxy effect,
optional at extra charge: varnishing in several configured colours;
- low aluminium threshold with a thermal break,
optional with extra charge with a system of warm sub-threshold profiles;
- four 3D adjustable hinges with increased burglary resistance, with covers in the color of the fittings;
- anti-burglary bolt system;
- three-point anti-burglary bolted lock, in the price of a standard door: handle, cylinder lock or automatic;
- a set of adjustable stainless steel latches;
- triple, perimeter sealing system;
- wind-stop seal – an additional seal in the door sill;
- version with glazing: four-pane glazing with a warm frame system

The price of the door includes one of many patterns of decorations from groups "0", "I" or "II"
optionally at extra charge: decorated stained glazing from group "III";

The price of the door includes a set of dedicated installation consoles.



The warmest doors in their class.

AP ARCTIC PLUS

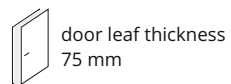

door leaf thickness
75 mm



thermal insulation
 U_d from 0,58 W/m²K



Rc2 anti-burglary
class



rebated
system



do not require
an overhang



Multi-point anti-burglary
strip locks

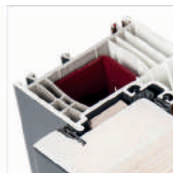

Six-chamber
PVC door frame



Four 3D adjustable
hinges

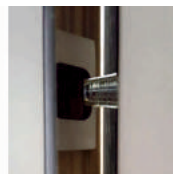

Anti-burglary bolts



Three-pane glazing
with a warm frame system



Silicone seals



Low aluminium threshold
with a thermal break



Wind-stop seal

STANDARD ACCESSORIES

Standard fittings for complete external doors from the ARCTIC PLUS line:

- **75 mm** thick composite door leaf with wood-like Real Wood surface structure on both sides
optionally with a SMOOTH surface, at extra charge;
optionally at extra charge: in any combination of both surfaces;
- PVC 85 mm door frame, six-chamber, class A Plus with identical surface for the leaf;
optionally at extra charge: meranti door frame
- complete doors varnished with the highest quality varnish in the RAL palette or in one of several wood-like decors,
optionally without extra charge with the pearl effect,
optional at extra charge: varnishing in several configured colours;
- low aluminium threshold with a thermal break,
optional with extra charge with a system of warm sub-threshold profiles;
- four 3D adjustable hinges with increased burglary resistance, with covers in the color of the fittings;
- anti-burglary bolt system;
- three-point anti-burglary bolted lock, in the price of a standard door: handle, cylinder lock or automatic;
- a set of adjustable stainless steel latches;
- triple, perimeter sealing system;
- wind-stop seal – an additional seal in the door sill;
- version with glazing: three-pane glazing with a warm frame system;

The price of the door includes one of many patterns of decorations from groups "0" or "I"
optionally at extra charge: decorated stained glazing from group "II" or "III";

The price of the door includes a set of dedicated installation consoles.

A ARCTIC

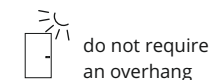
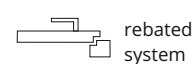
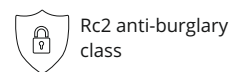
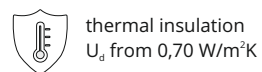
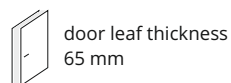

Multi-point anti-burglary strip locks



Six-chamber PVC door frame



Three 3D adjustable hinges



Anti-burglary bolts



Three-pane glazing with a warm frame system



Silicone seals



Low aluminium threshold with a thermal break



Wind-stop seal

STANDARD ACCESSORIES

Standard fittings for complete external doors from the ARCTIC line:

- **65 mm** thick composite door leaf with wood-like Real Wood surface structure on both sides *optionally with a SMOOTH surface, at extra charge; optionally at extra charge: in any combination of both surfaces;*
- PVC 85 mm door frame, six-chamber, class A Plus with identical surface for the leaf; *optionally at extra charge: meranti door frame*
- complete doors varnished with the highest quality varnish in the RAL palette or in one of several wood-like decors, *optionally without extra charge with the pearl effect, optional at extra charge: varnishing in several configured colours;*
- low aluminium threshold with a thermal break, *optional with extra charge with a system of warm sub-threshold profiles;*
- three 3D adjustable hinges with increased burglary resistance, with covers in the color of the fittings;
- anti-burglary bolt system;
- three-point anti-burglary strip lock bolted with a handle or cylinder lock, *optionally at extra charge: automatic locking;*
- a set of adjustable stainless steel latches;
- double, perimeter sealing system;
- wind-stop seal – an additional seal in the door sill;
- version with glazing: three-pane glazing with a warm frame system;

The price of the door includes one of many patterns of decorations from groups "0" or "I" *optionally at extra charge: decorated stained glazing from group "II" or "III";*

The price of the door includes a set of dedicated installation consoles.



ARCTIC line – composite doors for customers who value quality.

T TOP

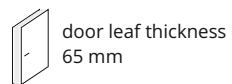

door leaf thickness
65 mm



thermal insulation
 U_g from 0,70 W/m²K



Rc2 anti-burglary
class*



rebated
system



do not require
an overhang



Multi-point anti-burglary
strip locks



Six-chamber
PVC door frame



Three 3D adjustable
hinges



Silicone seals



Three-pane glazing
with a warm frame system



Wind-stop seal



Low aluminium threshold
with a thermal break

STANDARD ACCESSORIES

Standard fittings for complete external doors from the TOP line:

- **65 mm** thick composite door leaf with wood-like Real Wood surface structure on both sides;
- PVC 85 mm door frame, six-chamber, class A Plus with wood-like Real Wood surface structure for the leaf;
- complete doors varnished with the highest quality varnish in the RAL palette, *optionally without extra charge with the pearl effect, optional at extra charge: wood-like decors;*
- low aluminium threshold with a thermal break, *optional with extra charge with a system of warm sub-threshold profiles;*
- three 3D adjustable hinges with increased burglary resistance, with covers in the color of the fittings;
- three-point anti-burglary strip lock bolted with a handle or cylinder lock;
- a set of adjustable stainless steel latches;
- double, perimeter sealing system;
- wind-stop seal - an additional seal in the door sill;
- version with glazing: three-pane glazing with a warm frame system;

The price of the door includes glazing from groups „0“ , *optionally at extra charge: decorated stained glazing from group „I“ ;*

* RC2 anti-burglary class according to the European standard PN-EN 1627 – optional, at extra charge.

The price of the door includes a set of dedicated installation consoles.

TIME FOR A GOOD CHOICE

Properties	ULTIMATE	ARCTIC ULTRA	ARCTIC PLUS	ARCTIC	TOP	OFFER OF COMPANY X
Thermal insulation according to the European standard PN-EN 14351	from 0,49 Wm ² /K	from 0,51 Wm ² /K	from 0,58 Wm ² /K	from 0,70 Wm ² /K	from 0,70 Wm ² /K	
Anti-burglary RC2 class according to the European standard PN-EN 1627	S	S	S	S	O	
Full overhang required	not required	not required	not required	not required	not required	
Periodic maintenance of paint coatings						
Warranty*	Door leaf	25 years	25 years	25 years	25 years	25 years
	Composite door frame	25 years	25 years	25 years	25 years	25 years
	PVC door frame	20 years	20 years	20 years	20 years	20 years
	Varnish coatings	5 years	5 years	5 years	5 years	5 years
	Other components	3 years	3 years	3 years	3 years	3 years
Composite door leaf - thickness in mm	90 mm	90 mm	75 mm	65 mm	65 mm	
PVC door frame - 6-chamber, A+ class	N/A	S	S	S	S	
Composite door frame	S	N/A	N/A	N/A	N/A	
Real Wood surface (wood-like)	S	S	S	S	S	
SMOOTH surface	O	O	O	O	N/A	
Varnishing in wood-like decors	S	S	S	S	O	
Multi-coloured varnishing	O	O	O	O	O	
Doors in non-standard sizes	O	O	O	O	N/A	
Doors according to customized design and fittings	O	O	O	O	N/A	
Sidelights and transom lights available according to custom designs	O	O	O	O	O	
Number of perimeter seals	2	3	3	2	2	
Low 20mm aluminium threshold with thermal break	S	S	S	S	S	
3-point lock with a handle	S	S	S	S	S	
3-point strip lock bolted automatically	S	S	S	O	O	
3-point lock, bolted with a cylinder	S	S	S	S	S	
strip lock bolted with two cylinder locks	O	O	O	O	N/A	
Adjustable stainless steel lock latches	S	S	S	S	S	
System latch strip in the frame	S	N/A	N/A	N/A	N/A	
Adjustable 3D hinges in the colour of the fittings	N/A	S	S	S	S	
Anti-burglary bolt system	S	S	S	S	O	
Hidden hinge system	S	N/A	N/A	N/A	N/A	
Glazing with a warm inter-pane frame	4-pane	3-pane	3-pane	3-pane	3-pane	
Decorated stained glazing	S	S	O	O	N/A	

S - standard; O - option; N/A - not applicable

* Check the detailed conditions contained in the warranty sheet.

When choosing doors and windows, make sure to check not only the purchase price. Compare parameters, fittings, and pay special attention to a very important feature of the products: their residual value. Seemingly more expensive composite doors compared to metal or wooden doors – due to their best heat protection, several dozen years of durability and lack of required maintenance – are more cost-effective after many years of trouble-free use.

DISCOVER OUR COLLECTIONS



DUO COLOR collection

DUO COLOR collection – selected door models, in which the main feature is the SMOOTH surface in black or in any other RAL color. It's a base for inspiration in creating any color variants. GALAXY pearl or electro powder effect – they will add splendor to your front door. Dare to be creative, color your world starting from your door!

Pages 22-23



DIPLOMAT collection

You will find the widest range of composite doors in the DIPLOMAT collection. This line is characterized by a multitude of configurations that will satisfy the most non-standard expectations, an extensive selection of doors, available in five lines, decorations and fittings – carefully selected according to your preferences. Legendary durability ensures the comfort and safety of your loved ones.

Pages 24-46



CLASSIC collection

In the CLASSIC collection, we present a design that combines classic forms with the lightness of FR milling. Composite entrance doors, varnished in one of the many decorations that are reminiscent of the nobility of natural wood, will emphasize the traditional, timeless style of your home. Are you looking for other decorations? There's nothing easier! Let's create your dream door together.

Pages 47-50



VINTAGE collection

Discover our offer of composite doors from the VINTAGE collection – beautiful rustic slats emphasizing the nobility of natural wood. Vertical, horizontal wood grain, or perhaps a customized arrangement? You decide on the layout, width and colors of the slats. Free your imagination – we'll be happy to meet your expectations!

Pages 52-53



STONE collection

A unique form of decoration that combines the nobility of Real Wood with the rawness of stone obtained from natural deposits. Many shades of ultra-thin stone slabs in almost any configuration of shapes and color combinations are designed for those looking for original aesthetic experiences. Let's break free from traditional clichés and common decorations.

Page 51



3D collection

The house is spacious, the house is 3D! That is why we created composite doors in the 3D collection – the three-dimensional shape of the door leaf is its main decorative accent. Painted in contrasting colors, they will additionally highlight the individual taste of your home. Available in the ARCTIC line – in the inward opening version.

Page 54

PRICES OF COMPOSITE DOORS

This price list contains factory net prices in EURO and applies to complete composite and factory-adjusted doors, according to the following specification:

- in standard sizes according to the dimension table - see page 72
optionally, for extra doors in non-standard sizes, see the price list for extra charges on page 66, items 1-3;
- in the standard version and available colors and special effects: according to the specifications of the line, see pages 14-19;
- with **RW** surface (fine wood structure) on both sides,
*optionally at extra charge: with **SMOOTH** surface, see price list of extra charges on page 68, items 36-40;*
optionally with two or more colors, see price list of extra charges on page 68, items 41-49;
- with any standard application variant for a given door model, see pages 22-53;
optional at extra charge: non-standard application variants - see price list of extra charges on page 68, items 50-58;
- available with one of the standard glazing packages from groups belonging to a given door line, see page 69;
optional, at extra charge: decorated glazing from group "I", "II" or "III" - see price list of extra charges on page 69, items 59-68;

Catalog of glazing packages, their decorations, stained glass and an assortment of panes with combination variants - available for download at www.vikking.eu/witraze

The price of the door includes a set of dedicated installation consoles (according to installation guidelines - see pages 73-74)

The price list of portals and lighting is available on page 71.

Note: FR, FL, RZ, IN, SG, LM and STONE are used on one side, by default on the outside of the building.

Note: Extra charges for non-standard options are specified on pages 59-71 of this catalog

Note: Prices of fittings and additional fittings are specified on pages 62-65 of this catalog

Note: Door designs and fittings according to individual designs - not included in this publication are priced upon request - contact: wyceny@vikking.eu.

The door visualizations presented in this catalog are options according to the customized configuration of colors and fittings. The door prices do not include accessories such as door handles, cylinder locks, pulls and extra charges for non-standard versions: the use of SMOOTH surfaces or a combination of two different surfaces on one side of the leaf, door varnishing in several colors and non-standard applications.

The printed colors may differ from the actual colors. We recommend checking the colors on samples available in stores.

Application variants

RW	Real Wood surface (fine wood structure)
SMOOTH	SMOOTH surface*
RW / SMOOTH	RW and SMOOTH surface on the outside of the leaf*
FR	milled decoration of the leaf surface - 10 mm - one-sided
FL	inox flush strip - 10 mm
RZ	inox flush frame
KZL	composite half-flush outer frame
KWL	composite half-flush internal frame
ZW	frameless on both sides system*
LC	inox threshold strip, surface height - 90 mm
STONE	Stone application from natural stone - semi-flush*
3D	3D leaf - available only in the ARCTIC line
IN	Inlay - non-standard decoration of the door with a semi-flush application from a composite board*
SG	Step Glass semi-flush with the leaf*
LM	Real Wood composite slats with horizontal grain or vertical grain - VINTAGE collection*

*not available in the TOP line

DUO COLOR COLLECTION

DUO COLOR C7



Available in the following lines:

- U** 2 770,00 €
- AU** 2 445,00 €
- AP** 2 230,00 €
- A** 2 015,00 €

Application variants

- Standard: FR SMOOTH
- Option: FL SMOOTH

DUO COLOR 3W



Available in the following lines:

- U** 2 950,00 €
- AU** 2 805,00 €
- AP** 2 410,00 €
- A** 2 195,00 €

Application variants

- Standard: KWL FR SMOOTH
- Option: ZW FL SMOOTH

DUO COLOR 3X



Available in the following lines:

- U** 3 055,00 €
- AU** 2 730,00 €
- AP** 2 515,00 €
- A** 2 300,00 €

Application variants

- Standard: KWL FR SMOOTH
- Option: ZW FL SMOOTH

DUO COLOR 0i



Available in the following lines:

- U** 2 770,00 €
- AU** 2 445,00 €
- AP** 2 230,00 €
- A** 2 015,00 €

Application variants

- Standard: FR SMOOTH
- Option: FL SMOOTH

Application variants on page 21; **Standard** - application included in the price; **Option** - application available at extra charge; **N/A** - application not available.

The prices do not include accessories such as door handles, cylinder locks, pulls and additional charges for non-standard varnishing in two colors and additional charges for making a smooth surface or connecting two different surfaces on one side of the leaf. The prices are net prices and do not include VAT.

MANY PATTERNS, COLOURS, AND CONFIGURATIONS

DUO COLOR 3Z



DUO COLOR 5Y



DUO COLOR 8J



DUO COLOR 8K



Available in the following lines:

U 3 055,00 €

AU 2 730,00 €

AP 2 515,00 €

A 2 300,00 €

Application variants

Standard: KWL FR SMOOTH

Option: ZW FR SMOOTH

Available in the following lines:

U 3 055,00 €

AU 2 730,00 €

AP 2 515,00 €

A 2 300,00 €

Application variants

Standard: KWL FR SMOOTH

Option: ZW FR SMOOTH

Available in the following lines:

U 3 055,00 €

AU 2 730,00 €

AP 2 515,00 €

A 2 300,00 €

Application variants

Standard: KWL FR SMOOTH

Option: ZW FR SMOOTH

Available in the following lines:

U 3 130,00 €

AU 2 805,00 €

AP 2 590,00 €

A 2 375,00 €

Application variants

Standard: KWL FR SMOOTH

Option: ZW FR SMOOTH

The DUO COLOR collection is an inspiration for creating unique doors. Because we specialize in custom designs, you can change the black surface to any color.

DIPLOMAT COLLECTION

DIPLOMAT S



Available in the following lines:

- U** 2 300,00 €
- AU** 1 980,00 €
- AP** 1 765,00 €
- A** 1 545,00 €
- T** 1 370,00 €

Application variants

Standard: N/A
Option: N/A

DIPLOMAT 9



Available in the following lines:

- U** 2 410,00 €
- AU** 2 085,00 €
- AP** 1 870,00 €
- A** 1 655,00 €
- T** 1 475,00 €

Application variants

Standard: FR
Option: FL

DIPLOMAT 0B



Available in the following lines:

- U** 2 410,00 €
- AU** 2 085,00 €
- AP** 1 870,00 €
- A** 1 655,00 €
- T** 1 475,00 €

Application variants

Standard: FR
Option: FL

DIPLOMAT 0F



Available in the following lines:

- U** 2 410,00 €
- AU** 2 085,00 €
- AP** 1 870,00 €
- A** 1 655,00 €
- T** 1 475,00 €

Application variants

Standard: FR
Option: FL

Application variants on page 21; **Standard** - application included in the price; **Option** - application available at extra charge; **N/A** - application not available.

The prices do not include accessories such as door handles, cylinder locks, pulls and additional charges for non-standard varnishing in two colors and additional charges for making a smooth surface or connecting two different surfaces on one side of the leaf. The prices are net prices and do not include VAT.

MANY PATTERNS, COLOURS, AND CONFIGURATIONS

DIPLOMAT 0K



DIPLOMAT 0M



DIPLOMAT 0N



DIPLOMAT 0T



DOOR LEAF IN TWO COLORS - OPTIONAL

Available in the following lines:

- U** 2 130,00 €
- AU** 2 085,00 €
- AP** 1 870,00 €
- A** 1 655,00 €
- T** 1 475,00 €

Application variants

Standard: FR
 Option: FL

Available in the following lines:

- U** 2 410,00 €
- AU** 2 085,00 €
- AP** 1 870,00 €
- A** 1 655,00 €
- T** 1 475,00 €

Application variants

Standard: FR
 Option: FL

Available in the following lines:

- U** 2 410,00 €
- AU** 2 085,00 €
- AP** 1 870,00 €
- A** 1 655,00 €
- T** 1 475,00 €

Application variants

Standard: FR
 Option: N/A

Available in the following lines:

- U** 2 410,00 €
- AU** 2 085,00 €
- AP** 1 870,00 €
- A** 1 655,00 €
- T** 1 475,00 €

Application variants

Standard: FR
 Option: N/A

Decide if your door will have a Real Wood wood-like surface or a SMOOTH surface.

All RAL colors are also available without additional charges with the pearl effect or the GALAXY powder effect. Don't forget to mark it in your order!

DIPLOMAT COLLECTION

DIPLOMAT 0Z



Available in the following lines:

- U** 2 410,00 €
- AU** 2 085,00 €
- AP** 1 870,00 €
- A** 1 655,00 €
- T** 1 475,00 €

Application variants

Standard: FL or IN

Option: N/A

DIPLOMAT A2



Available in the following lines:

- U** 2 410,00 €
- AU** 2 085,00 €
- AP** 1 870,00 €
- A** 1 655,00 €
- T** 1 475,00 €

Application variants

Standard: FR

Option: FL

DIPLOMAT A4



Available in the following lines:

- U** 2 410,00 €
- AU** 2 085,00 €
- AP** 1 870,00 €
- A** 1 655,00 €
- T** 1 475,00 €

Application variants

Standard: FR

Option: FL

DIPLOMAT A5

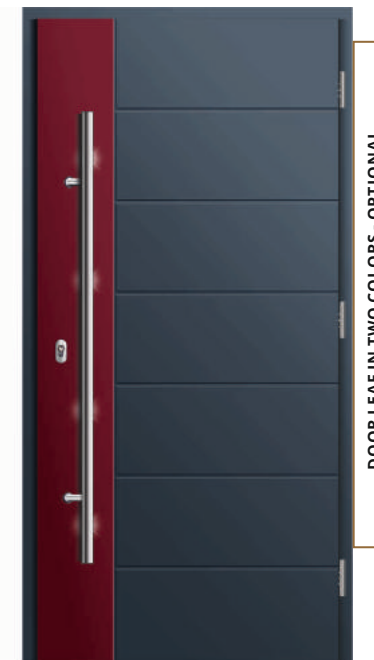

Available in the following lines:

- U** 2 410,00 €
- AU** 2 085,00 €
- AP** 1 870,00 €
- A** 1 655,00 €
- T** 1 475,00 €

Application variants

Standard: FR

Option: FL

Application variants on page 21; **Standard** - application included in the price; **Option** - application available at extra charge; **N/A** - application not available.

The prices do not include accessories such as door handles, cylinder locks, pulls and additional charges for non-standard varnishing in two colors and additional charges for making a smooth surface or connecting two different surfaces on one side of the leaf. The prices are net prices and do not include VAT.

MANY PATTERNS, COLOURS, AND CONFIGURATIONS

DIPLOMAT A6



DIPLOMAT A7



DIPLOMAT B1



DIPLOMAT B3



Available in the following lines:

- U** 2 410,00 €
- AU** 2 085,00 €
- AP** 1 870,00 €
- A** 1 655,00 €
- T** 1 475,00 €

Application variants

Standard: FR
Option: FL

Available in the following lines:

- U** 2 410,00 €
- AU** 2 085,00 €
- AP** 1 870,00 €
- A** 1 655,00 €
- T** 1 475,00 €

Application variants

Standard: FR
Option: N/A

Available in the following lines:

- U** 2 410,00 €
- AU** 2 085,00 €
- AP** 1 870,00 €
- A** 1 655,00 €
- T** 1 475,00 €

Application variants

Standard: FR
Option: N/A

Available in the following lines:

- U** 2 410,00 €
- AU** 2 085,00 €
- AP** 1 870,00 €
- A** 1 655,00 €
- T** 1 475,00 €

Application variants

Standard: FR
Option: N/A

All the doors can be varnished in two or even three colors!

Did you know?
In the design and production process, we are committed to protecting the environment for future generations.

DIPLOMAT COLLECTION

DIPLOMAT B6



Available in the following lines:

- U** 2 410,00 €
- AU** 2 085,00 €
- AP** 1 870,00 €
- A** 1 655,00 €
- T** 1 475,00 €

Application variants

Standard: FR
 Option: N/A

DIPLOMAT C3



Available in the following lines:

- U** 2 410,00 €
- AU** 2 085,00 €
- AP** 1 870,00 €
- A** 1 655,00 €
- T** 1 475,00 €

Application variants

Standard: FR
 Option: N/A

DIPLOMAT C4



Available in the following lines:

- U** 2 410,00 €
- AU** 2 085,00 €
- AP** 1 870,00 €
- A** 1 655,00 €
- T** 1 475,00 €

Application variants

Standard: FR
 Option: N/A

DIPLOMAT 1D



Available in the following lines:

- U** 2 680,00 €
- AU** 2 390,00 €
- AP** 2 140,00 €
- A** 1 925,00 €
- T** 1 745,00 €

Application variants

Standard: KWL FR
 Option: ZW FR

Application variants on page 21; **Standard** - application included in the price; **Option** - application available at extra charge; **N/A** - application not available.

The prices do not include accessories such as door handles, cylinder locks, pulls and additional charges for non-standard varnishing in two colors and additional charges for making a smooth surface or connecting two different surfaces on one side of the leaf. The prices are net prices and do not include VAT.

MANY PATTERNS, COLOURS, AND CONFIGURATIONS

DIPLOMAT 1H



DIPLOMAT 1i



DIPLOMAT 1J



DIPLOMAT 1L



Available in the following lines:

- U** 2 770,00 €
- AU** 2 445,00 €
- AP** 2 230,00 €
- A** 2 015,00 €
- T** 1 835,00 €

Application variants

Standard: KWL FR
 Option: ZW FR

Available in the following lines:

- U** 2 770,00 €
- AU** 2 445,00 €
- AP** 2 230,00 €
- A** 2 015,00 €
- T** 1 835,00 €

Application variants

Standard: KWL FR
 Option: ZW FR

Available in the following lines:

- U** 2 770,00 €
- AU** 2 445,00 €
- AP** 2 230,00 €
- A** 2 015,00 €
- T** 1 835,00 €

Application variants

Standard: KWL FR
 Option: ZW FR

Available in the following lines:

- U** 2 770,00 €
- AU** 2 445,00 €
- AP** 2 230,00 €
- A** 2 015,00 €
- T** 1 835,00 €

Application variants

Standard: KWL FR
 Option: ZW FR

Did you know?
 Composite doors do not require an overhang
 and do not have restrictions in terms of their proximity to heating devices.

DIPLOMAT COLLECTION

DIPLOMAT 1S



Available in the following lines:

- U** 2 770,00 €
- AU** 2 445,00 €
- AP** 2 230,00 €
- A** 2 015,00 €
- T** 1 835,00 €

Application variants

Standard: KWL FR
 Option: ZW FR

DIPLOMAT 1T



Available in the following lines:

- U** 2 770,00 €
- AU** 2 445,00 €
- AP** 2 230,00 €
- A** 2 015,00 €
- T** 1 835,00 €

Application variants

Standard: KWL FR
 Option: ZW FR

DIPLOMAT 1W



Available in the following lines:

- U** 2 680,00 €
- AU** 2 390,00 €
- AP** 2 140,00 €
- A** 1 925,00 €
- T** 1 745,00 €

Application variants

Standard: KWL FR
 Option: ZW FR

DIPLOMAT 20



Available in the following lines:

- U** 2 770,00 €
- AU** 2 445,00 €
- AP** 2 230,00 €
- A** 2 015,00 €
- T** 1 835,00 €

Application variants

Standard: RZ or KZL
 Option: N/A

Application variants on page 21; **Standard** - application included in the price; **Option** - application available at extra charge; **N/A** - application not available.

The prices do not include accessories such as door handles, cylinder locks, pulls and additional charges for non-standard varnishing in two colors and additional charges for making a smooth surface or connecting two different surfaces on one side of the leaf. The prices are net prices and do not include VAT.

MANY PATTERNS, COLOURS, AND CONFIGURATIONS

DIPLOMAT 26



DIPLOMAT 2d



DIPLOMAT 2F



DIPLOMAT 2G



Available in the following lines:

- U** 2 805,00 €
- AU** 2 480 €
- AP** 2 265,00 €
- A** 2 050,00 €
- T** 1 870,00 €

Application variants

Standard: **RZ** or **KZL**

Option: N/A

Available in the following lines:

- U** 2 770,00 €
- AU** 2 445,00 €
- AP** 2 230,00 €
- A** 2 015,00 €
- T** 1 835,00 €

Application variants

Standard: **RZ** or **KZL**

Option: N/A

Available in the following lines:

- U** 2 730,00 €
- AU** 2 410,00 €
- AP** 2 190,00 €
- A** 1 980,00 €
- T** 1 800,00 €

Application variants

Standard: **RZ** or **KZL**

Option: N/A

Available in the following lines:

- U** 2 680,00 €
- AU** 2 355,00 €
- AP** 2 140,00 €
- A** 1 925,00 €
- T** 1 745,00 €

Application variants

Standard: **KWL** **FR** **FL**

Option: N/A

INOX frames can be replaced with composite frames varnished in any color.

Did you know?
Thanks to the use of fiberglass, composite doors do not require tedious and frequent maintenance. They are unbreakable, and their unsurpassed durability ensures security for generations.

DIPLOMAT COLLECTION

DIPLOMAT 2H



Available in the following lines:

- U** 2 680,00 €
- AU** 2 355,00 €
- AP** 2 140,00 €
- A** 1 925,00 €
- T** 1 745,00 €

Application variants

Standard: KWL FR
 Option: ZW FR

DIPLOMAT 2i



Available in the following lines:

- U** 2 680,00 €
- AU** 2 355,00 €
- AP** 2 140,00 €
- A** 1 925,00 €
- T** 1 745,00 €

Application variants

Standard: KWL FR
 Option: ZW FR

DIPLOMAT 31



Available in the following lines:

- U** 2 770,00 €
- AU** 2 445,00 €
- AP** 2 230,00 €
- A** 2 015,00 €
- T** 1 835,00 €

Application variants

Standard: KWL FR
 Option: ZW FR

DIPLOMAT 32



Available in the following lines:

- U** 2 625,00 €
- AU** 2 300,00 €
- AP** 2 085,00 €
- A** 1 870,00 €
- T** 1 690,00 €

Application variants

Standard: KWL FR
 Option: ZW FR

Application variants on page 21; **Standard** - application included in the price; **Option** - application available at extra charge; **N/A** - application not available.

The prices do not include accessories such as door handles, cylinder locks, pulls and additional charges for non-standard varnishing in two colors and additional charges for making a smooth surface or connecting two different surfaces on one side of the leaf. The prices are net prices and do not include VAT.

MANY PATTERNS, COLOURS, AND CONFIGURATIONS

DIPLOMAT 33



DIPLOMAT 36



DIPLOMAT 38



DIPLOMAT 39



Available in the following lines:

- U** 2 730,00 €
- AU** 2 410,00 €
- AP** 2 195,00 €
- A** 1 980,00 €
- T** 1 800,00 €

Application variants

Standard: KWL FR
 Option: ZW FR

Available in the following lines:

- U** 2 715,00 €
- AU** 2 390,00 €
- AP** 2 175,00 €
- A** 1 960,00 €
- T** 1 780,00 €

Application variants

Standard: KWL FR
 Option: ZW FR

Available in the following lines:

- U** 2 715,00 €
- AU** 2 390,00 €
- AP** 2 175,00 €
- A** 1 960,00 €
- T** 1 780,00 €

Application variants

Standard: KWL FR
 Option: ZW FR

Available in the following lines:

- U** 2 715,00 €
- AU** 2 390,00 €
- AP** 2 175,00 €
- A** 1 960,00 €
- T** 1 780,00 €

Application variants

Standard: KWL FR
 Option: ZW FR

Did you know?
 Glazing packages in composite doors have super warm inter-pane frames.
 This significantly improves their energy efficiency and acoustic comfort.

DIPLOMAT COLLECTION

DIPLOMAT 3Y



Available in the following lines:

- U** 2 625,00 €
- AU** 2 300,00 €
- AP** 2 085,00 €
- A** 1 870,00 €
- T** 1 690,00 €

Application variants

Standard: KWL FR
 Option: ZW FR

DIPLOMAT 40



Available in the following lines:

- U** 2 730,00 €
- AU** 2 410,00 €
- AP** 2 195,00 €
- A** 1 980,00 €
- T** 1 800,00 €

Application variants

Standard: RZ or KZL
 Option: N/A

DIPLOMAT 44



Available in the following lines:

- U** 2 730,00 €
- AU** 2 410,00 €
- AP** 2 195,00 €
- A** 1 980,00 €
- T** 1 800,00 €

Application variants

Standard: RZ or KZL
 Option: N/A

DIPLOMAT 46



Available in the following lines:

- U** 2 625,00 €
- AU** 2 300,00 €
- AP** 2 085,00 €
- A** 1 870,00 €
- T** 1 690,00 €

Application variants

Standard: RZ or KZL
 Option: N/A

Application variants on page 21; **Standard** - application included in the price; **Option** - application available at extra charge; **N/A** - application not available.

The prices do not include accessories such as door handles, cylinder locks, pulls and additional charges for non-standard varnishing in two colors and additional charges for making a smooth surface or connecting two different surfaces on one side of the leaf. The prices are net prices and do not include VAT.

MANY PATTERNS, COLOURS, AND CONFIGURATIONS

DIPLOMAT 4E



DIPLOMAT 4H



DIPLOMAT 4i



DIPLOMAT 4J



Available in the following lines:

- U** 2 770,00 €
- AU** 2 445,00 €
- AP** 2 230,00 €
- A** 2 015,00 €
- T** 1 835,00 €

Application variants

Standard: **RZ** or **KZL**

Option: N/A

Available in the following lines:

- U** 2 625,00 €
- AU** 2 300,00 €
- AP** 2 085,00 €
- A** 1 870,00 €
- T** 1 690,00 €

Application variants

Standard: **RZ** or **KZL**

Option: N/A

Available in the following lines:

- U** 2 590,00 €
- AU** 2 265,00 €
- AP** 2 050,00 €
- A** 1 835,00 €
- T** 1 655,00 €

Application variants

Standard: **RZ** or **KZL**

Option: N/A

Available in the following lines:

- U** 2 590,00 €
- AU** 2 265,00 €
- AP** 2 050,00 €
- A** 1 835,00 €
- T** 1 655,00 €

Application variants

Standard: **RZ** or **KZL**

Option: N/A

Did you know?

Composite doors are made only of materials that protect against the loss of valuable energy. And that means significant savings in home heating!

DIPLOMAT COLLECTION

DIPLOMAT 4N



COMPOSITE FRAME IN THE SMOOTH VERSION - OPTIONAL

Available in the following lines:

- U** 2 625,00 €
- AU** 2 300,00 €
- AP** 2 085,00 €
- A** 1 870,00 €
- T** 1 690,00 €

Application variants

Standard: RZ or KZL

Option: N/A

DIPLOMAT 4P



COMPOSITE FRAME IN THE SMOOTH VERSION - OPTIONAL

Available in the following lines:

- U** 2 625,00 €
- AU** 2 300,00 €
- AP** 2 085,00 €
- A** 1 870,00 €
- T** 1 690,00 €

Application variants

Standard: RZ or KZL

Option: N/A

DIPLOMAT 4U



Available in the following lines:

- U** 2 625,00 €
- AU** 2 300,00 €
- AP** 2 085,00 €
- A** 1 870,00 €
- T** 1 690,00 €

Application variants

Standard: RZ or KZL

Option: N/A

DIPLOMAT 4V

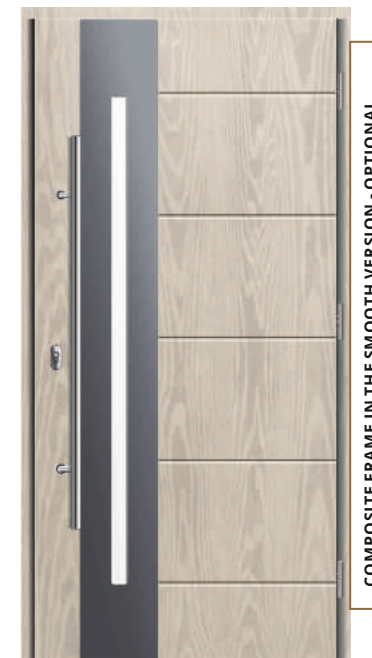

COMPOSITE FRAME IN THE SMOOTH VERSION - OPTIONAL

Available in the following lines:

- U** 2 625,00 €
- AU** 2 300,00 €
- AP** 2 085,00 €
- A** 1 870,00 €
- T** 1 690,00 €

Application variants

Standard: RZ FR

Option: RZ FL

Application variants on page 21; **Standard** - application included in the price; **Option** - application available at extra charge; **N/A** - application not available.

The prices do not include accessories such as door handles, cylinder locks, pulls and additional charges for non-standard varnishing in two colors and additional charges for making a smooth surface or connecting two different surfaces on one side of the leaf. The prices are net prices and do not include VAT.

MANY PATTERNS, COLOURS, AND CONFIGURATIONS

DIPLOMAT 4W



DIPLOMAT 4X

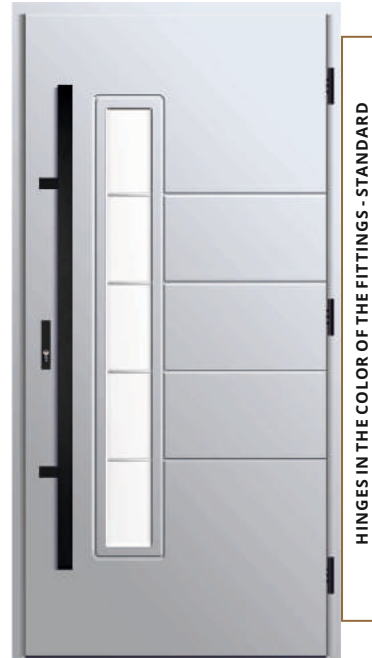

DIPLOMAT 4Y

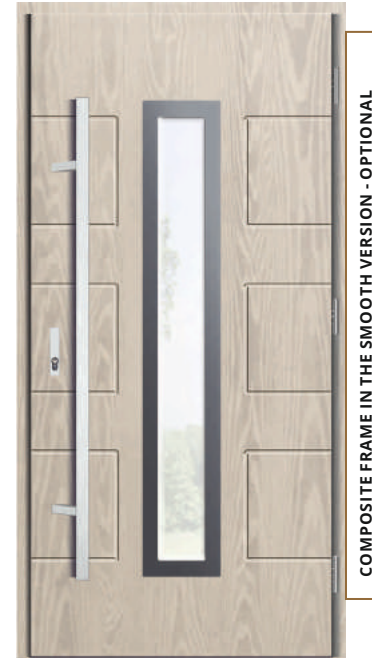

DIPLOMAT 4Z



Available in the following lines:

- U** 2 680,00 €
- AU** 2 355,00 €
- AP** 2 140,00 €
- A** 1 925,00 €
- T** 1 745,00 €

Application variants

Standard: **KWL** **FR**
 Option: **ZW** **FR**

Available in the following lines:

- U** 2 680,00 €
- AU** 2 355,00 €
- AP** 2 140,00 €
- A** 1 925,00 €
- T** 1 745,00 €

Application variants

Standard: **KWL** **FR**
 Option: **ZW** **FR**

Available in the following lines:

- U** 2 680,00 €
- AU** 2 355,00 €
- AP** 2 140,00 €
- A** 1 925,00 €
- T** 1 745,00 €

Application variants

Standard: **RZ** **FR** or **KZL** **FR**
 Option: N/A

Available in the following lines:

- U** 2 715,00 €
- AU** 2 390,00 €
- AP** 2 175,00 €
- A** 1 960,00 €
- T** 1 780,00 €

Application variants

Standard: **KWL**
 Option: **ZW**

Decorative frames of glazing packages in contrasting colors will add splendor to your door.

Did you know?
 Our composite doors are equipped with a functional LED lighting system in any configuration: in the glazing of the leaf, in the threshold part, in the sidelight, or in the pull.

DIPLOMAT COLLECTION

DIPLOMAT 52



DIPLOMAT 53



DIPLOMAT 54



DIPLOMAT 55



Available in the following lines:

- U** 2 715,00 €
- AU** 2 390,00 €
- AP** 2 175,00 €
- A** 1 960,00 €
- T** 1 780,00 €

Application variants

Standard: **RZ** **FR** or **KZL** **FR**

Option: N/A

Available in the following lines:

- U** 2 840,00 €
- AU** 2 515,00 €
- AP** 2 300,00 €
- A** 2 085,00 €
- T** 1 905,00 €

Application variants

Standard: **KWL** **FR**

Option: **ZW** **FR**

Available in the following lines:

- U** 2 840,00 €
- AU** 2 515,00 €
- AP** 2 300,00 €
- A** 2 085,00 €
- T** 1 905,00 €

Application variants

Standard: **KWL** **FR**

Option: **ZW** **FR**

Available in the following lines:

- U** 2 735,00 €
- AU** 2 410,00 €
- AP** 2 195,00 €
- A** 1 980,00 €
- T** 1 800,00 €

Application variants

Standard: **KWL** **FR**

Option: **ZW** **FR**

Application variants on page 21; **Standard** - application included in the price; **Option** - application available at extra charge; **N/A** - application not available.

The prices do not include accessories such as door handles, cylinder locks, pulls and additional charges for non-standard varnishing in two colors and additional charges for making a smooth surface or connecting two different surfaces on one side of the leaf. The prices are net prices and do not include VAT.

MANY PATTERNS, COLOURS, AND CONFIGURATIONS

DIPLOMAT 5d



DIPLOMAT 5E



DIPLOMAT 5F



DIPLOMAT 5G



Available in the following lines:

- U** 2 590,00 €
- AU** 2 265,00 €
- AP** 2 050,00 €
- A** 1 835,00 €
- T** 1 655,00 €

Application variants

Standard: KWL FR
 Option: ZW FR

Available in the following lines:

- U** 2 590,00 €
- AU** 2 265,00 €
- AP** 2 050,00 €
- A** 1 835,00 €
- T** 1 655,00 €

Application variants

Standard: KWL FR
 Option: ZW FR

Available in the following lines:

- U** 2 625,00 €
- AU** 2 300,00 €
- AP** 2 085,00 €
- A** 1 870,00 €
- T** 1 690,00 €

Application variants

Standard: RZ or KZL
 Option: N/A

Available in the following lines:

- U** 2 625,00 €
- AU** 2 300,00 €
- AP** 2 085,00 €
- A** 1 870,00 €
- T** 1 690,00 €

Application variants

Standard: KWL FR
 Option: ZW FR

Did you know?

Only composite doors have reinforced, adjustable 3D hinges in the same color as the fittings. You don't have to pay for extra covers.

- All RAL colors available without additional charges, also with the pearl effect or the GALAXY powder effect. Don't forget to mark it in your order!

DIPLOMAT COLLECTION

DIPLOMAT 5H



Available in the following lines:

- U** 2 695,00 €
- AU** 2 375,00 €
- AP** 2 155,00 €
- A** 1 945,00 €
- T** 1 765,00 €

Application variants

Standard: KWL FR
 Option: ZW FR

DIPLOMAT 5L



Available in the following lines:

- U** 2 590,00 €
- AU** 2 265,00 €
- AP** 2 050,00 €
- A** 1 835,00 €
- T** 1 655,00 €

Application variants

Standard: KWL FR
 Option: ZW FR

DIPLOMAT 5T



Available in the following lines:

- U** 2 625,00 €
- AU** 2 300,00 €
- AP** 2 085,00 €
- A** 1 870,00 €
- T** 1 690,00 €

Application variants

Standard: RZ FR or KZL FR
 Option: N/A

DIPLOMAT 5U



Available in the following lines:

- U** 2 625,00 €
- AU** 2 300,00 €
- AP** 2 085,00 €
- A** 1 870,00 €
- T** 1 690,00 €

Application variants

Standard: KWL FR
 Option: ZW FR

Application variants on page 21; **Standard** - application included in the price; **Option** - application available at extra charge; **N/A** - application not available.

The prices do not include accessories such as door handles, cylinder locks, pulls and additional charges for non-standard varnishing in two colors and additional charges for making a smooth surface or connecting two different surfaces on one side of the leaf. The prices are net prices and do not include VAT.

MANY PATTERNS, COLOURS, AND CONFIGURATIONS

DIPLOMAT 5V



DIPLOMAT 5W



DIPLOMAT 5X



DIPLOMAT 68



Available in the following lines:

- U** 2 625,00 €
- AU** 2 300,00 €
- AP** 2 085,00 €
- A** 1 870,00 €
- T** 1 690,00 €

Application variants

Standard: KWL FR
 Option: ZW FR

Available in the following lines:

- U** 2 625,00 €
- AU** 2 300,00 €
- AP** 2 085,00 €
- A** 1 870,00 €
- T** 1 690,00 €

Application variants

Standard: KWL FR
 Option: ZW FR

Available in the following lines:

- U** 2 625,00 €
- AU** 2 300,00 €
- AP** 2 085,00 €
- A** 1 870,00 €
- T** 1 690,00 €

Application variants

Standard: KWL FR
 Option: ZW FR

Available in the following lines:

- U** 2 735,00 €
- AU** 2 410,00 €
- AP** 2 195,00 €
- A** 1 980,00 €
- T** 1 800,00 €

Application variants

Standard: RZ or KZL
 Option: N/A

Did you know?

Composite doors, unlike doors made of traditional materials, do not corrode, they are resistant to moisture and harmful UV radiation, and the door leaves do not deform due to the influence of weather conditions.

DIPLOMAT COLLECTION

DIPLOMAT 6H



Available in the following lines:

- U** 2 730,00 €
- AU** 2 410,00 €
- AP** 2 195,00 €
- A** 1 980,00 €
- T** 1 800,00 €

Application variants

Standard: RZ or KZL

Option: N/A

DIPLOMAT 6i



Available in the following lines:

- U** 2 730,00 €
- AU** 2 410,00 €
- AP** 2 195,00 €
- A** 1 980,00 €
- T** 1 800,00 €

Application variants

Standard: KWL FR

Option: ZW FR

DIPLOMAT 6J



Available in the following lines:

- U** 2 730,00 €
- AU** 2 410,00 €
- AP** 2 195,00 €
- A** 1 980,00 €
- T** 1 800,00 €

Application variants

Standard: KWL FR

Option: ZW FR

DIPLOMAT 6L



Available in the following lines:

- U** 2 700,00 €
- AU** 2 380,00 €
- AP** 2 165,00 €
- A** 1 950,00 €
- T** 1 770,00 €

Application variants

Standard: RZ or KZL

Option: N/A

Application variants on page 21; **Standard** - application included in the price; **Option** - application available at extra charge; **N/A** - application not available.

The prices do not include accessories such as door handles, cylinder locks, pulls and additional charges for non-standard varnishing in two colors and additional charges for making a smooth surface or connecting two different surfaces on one side of the leaf. The prices are net prices and do not include VAT.

MANY PATTERNS, COLOURS, AND CONFIGURATIONS

DIPLOMAT 7F



Available in the following lines:

- U** 2 805,00 €
- AU** 2 480,00 €
- AP** 2 265,00 €
- A** 2 050,00 €
- T** 1 870,00 €

Application variants

Standard: **RZ** or **KZL**

Option: N/A

DIPLOMAT 7J



Available in the following lines:

- U** 2 805,00 €
- AU** 2 480,00 €
- AP** 2 265,00 €
- A** 2 050,00 €
- T** 1 870,00 €

Application variants

Standard: **KWL** **FR**

Option: **ZW** **FR**

DIPLOMAT 7K



Available in the following lines:

- U** 2 770,00 €
- AU** 2 445,00 €
- AP** 2 230,00 €
- A** 2 015,00 €
- T** 1 835,00 €

Application variants

Standard: **KWL** **FR**

Option: **ZW** **FR**

DIPLOMAT 7L



Available in the following lines:

- U** 2 805,00 €
- AU** 2 480,00 €
- AP** 2 265,00 €
- A** 2 050,00 €
- T** 1 870,00 €

Application variants

Standard: **RZ** **FR** or **KZL** **FR**

Option: N/A

Feel the magic of colors, only the composite doors are available without any limitations, in the full range of colors.

Did you know?
We make glazing packages and stained glass decorations in our own studio, nothing is impossible for us.

DIPLOMAT COLLECTION

DIPLOMAT 89



Available in the following lines:

- U** 2 875,00 €
- AU** 2 555,00 €
- AP** 2 335,00 €
- A** 2 120,00 €

Application variants

Standard: **RZ** or **KZL**

Option: N/A

DIPLOMAT 8C



Available in the following lines:

- U** 2 805,00 €
- AU** 2 480,00 €
- AP** 2 265,00 €
- A** 2 050,00 €

Application variants

Standard: **KWL** **FR**

Option: **ZW** **FR**

DIPLOMAT 8d



Available in the following lines:

- U** 2 875,00 €
- AU** 2 555,00 €
- AP** 2 335,00 €
- A** 2 120,00 €

Application variants

Standard: **KWL** **FR** **FL**

Option: **ZW** **FR** **FL**

DIPLOMAT 8F



Available in the following lines:

- U** 2 875,00 €
- AU** 2 255,00 €
- AP** 2 355,00 €
- A** 2 120,00 €

Application variants

Standard: **KWL** **FR** **FL**

Option: **ZW** **FR** **FL**

Application variants on page 21; **Standard** - application included in the price; **Option** - application available at extra charge; **N/A** - application not available.

The prices do not include accessories such as door handles, cylinder locks, pulls and additional charges for non-standard varnishing in two colors and additional charges for making a smooth surface or connecting two different surfaces on one side of the leaf. The prices are net prices and do not include VAT.

MANY PATTERNS, COLOURS, AND CONFIGURATIONS

DIPLOMAT 8G



DIPLOMAT 8H



DIPLOMAT 8i



DIPLOMAT 8L



Available in the following lines:

- U** 2 695,00 €
- AU** 2 375,00 €
- AP** 2 155,00 €
- A** 1 945,00 €
- T** 1 765,00 €

Application variants

Standard: KWL FR
 Option: ZW FR

Available in the following lines:

- U** 2 670,00 €
- AU** 2 335,00 €
- AP** 2 120,00 €
- A** 1 905,00 €
- T** 1 725,00 €

Application variants

Standard: KWL FR
 Option: ZW FR

Available in the following lines:

- U** 2 670,00 €
- AU** 2 335,00 €
- AP** 2 120,00 €
- A** 1 905,00 €
- T** 1 725,00 €

Application variants

Standard: KWL FR
 Option: ZW FR

Available in the following lines:

- U** 2 730,00 €
- AU** 2 410,00 €
- AP** 2 190,00 €
- A** 1 980,00 €
- T** 1 800,00 €

Application variants

Standard: RZ FR
 Option: ZW FR

Did you know?

You decide about the size, fittings, colors and decorations of your composite doors. We will handle the rest with the utmost care and the commitment of our experts.

DIPLOMAT COLLECTION

DIPLOMAT 8M



Available in the following lines:

- U** 2 625,00 €
- AU** 2 300,00 €
- AP** 2 085,00 €
- A** 1 870,00 €
- T** 1 690,00 €

Application variants

Standard: KWL FR
 Option: ZW FR

DIPLOMAT 8R



Available in the following lines:

- U** 2 805,00 €
- AU** 2 480,00 €
- AP** 2 265,00 €
- A** 2 050,00 €
- T** 1 870,00 €

Application variants

Standard: RZ FR or KZL FR
 Option: N/A

DIPLOMAT 8S



Available in the following lines:

- U** 2 875,00 €
- AU** 2 255,00 €
- AP** 2 335,00 €
- A** 2 120,00 €

Application variants

Standard: KWL FR
 Option: ZW FR

DIPLOMAT 8T



Available in the following lines:

- U** 2 445,00 €
- AU** 2 120,00 €
- AP** 1 905,00 €
- A** 1 690,00 €
- T** 1 510,00 €

Application variants

Standard: FR
 Option: N/A

Application variants on page 21; **Standard** - application included in the price; **Option** - application available at extra charge; **N/A** - application not available.

The prices do not include accessories such as door handles, cylinder locks, pulls and additional charges for non-standard varnishing in two colors and additional charges for making a smooth surface or connecting two different surfaces on one side of the leaf. The prices are net prices and do not include VAT.

CLASSIC COLLECTION

CLASSIC 011



CLASSIC 012



CLASSIC 021



CLASSIC 022



Available in the following lines:

- U** 2 480,00 €
- AU** 2 155,00 €
- AP** 1 940,00 €
- A** 1 725,00 €
- T** 1 545,00 €

Application variants

Standard: FR

Option: N/A

Available in the following lines:

- U** 2 665,00 €
- AU** 2 335,00 €
- AP** 2 120,00 €
- A** 1 905,00 €
- T** 1 725,00 €

Application variants

Standard: KWL FR

Option: N/A

Available in the following lines:

- U** 2 445,00 €
- AU** 2 12,00 €
- AP** 1 905,00 €
- A** 1 690,00 €
- T** 1 510,00 €

Application variants

Standard: FR

Option: N/A

Available in the following lines:

- U** 2 680,00 €
- AU** 2 355,00 €
- AP** 2 140,00 €
- A** 1 925,00 €
- T** 1 745,00 €

Application variants

Standard: KWL FR

Option: N/A

Did you know?
We recommend applying a door latch hidden in the frame.
Your invisible helper - when you walk through the door with your hands full with packages.

CLASSIC COLLECTION

CLASSIC 031



Available in the following lines:

- U** 2 445,00 €
- AU** 2 120,00 €
- AP** 1 905,00 €
- A** 1 690,00 €
- T** 1 510,00 €

Application variants

Standard: FR
 Option: N/A

CLASSIC 032



Available in the following lines:

- U** 2 680,00 €
- AU** 2 355,00 €
- AP** 2 140,00 €
- A** 1 925,00 €
- T** 1 745,00 €

Application variants

Standard: KWL FR
 Option: N/A

CLASSIC 034



Available in the following lines:

- U** 2 695,00 €
- AU** 2 375,00 €
- AP** 2 155,00 €
- A** 1 945,00 €
- T** 1 765,00 €

Application variants

Standard: KWL FR
 Option: N/A

CLASSIC 041



Available in the following lines:

- U** 2 480,00 €
- AU** 2 155,00 €
- AP** 1 940,00 €
- A** 1 725,00 €
- T** 1 545,00 €

Application variants

Standard: FR
 Option: N/A

Application variants on page 21; **Standard** - application included in the price; **Option** - application available at extra charge; **N/A** - application not available.

The prices do not include accessories such as door handles, cylinder locks, pulls and additional charges for non-standard varnishing in two colors and additional charges for making a smooth surface or connecting two different surfaces on one side of the leaf. The prices are net prices and do not include VAT.

CLASSIC COLLECTION

CLASSIC 042



CLASSIC 051



CLASSIC 054



CLASSIC 061



Available in the following lines:

- U** 2 695,00 €
- AU** 2 375,00 €
- AP** 2 155,00 €
- A** 1 945,00 €
- T** 1 765,00 €

Application variants

Standard: **KWL** **FR**

Option: N/A

Available in the following lines:

- U** 2 410,00 €
- AU** 2 085,00 €
- AP** 1 870,00 €
- A** 1 655,00 €
- T** 1 475,00 €

Application variants

Standard: **FR**

Option: N/A

Available in the following lines:

- U** 2 735,00 €
- AU** 2 410,00 €
- AP** 2 190,00 €
- A** 1 980,00 €
- T** 1 780,00 €

Application variants

Standard: **KWL** **FR**

Option: N/A

Available in the following lines:

- U** 2 410,00 €
- AU** 2 085,00 €
- AP** 1 870,00 €
- A** 1 655,00 €
- T** 1 475,00 €

Application variants

Standard: **FR**

Option: N/A

Did you know?
 A multi-point lock in an automatic version blocks the door leaf after each closing.
 Just turn the key or knob of the cylinder lock and your house is fully protected.

CLASSIC COLLECTION

CLASSIC 062



Available in the following lines:

- U** 2 735,00 €
- AU** 2 410,00 €
- AP** 2 195,00 €
- A** 1 980,00 €
- T** 1 780,00 €

Application variants

Standard: KWL FR

Option: N/A

CLASSIC 063



Available in the following lines:

- U** 2 410,00 €
- AU** 2 085,00 €
- AP** 1 870,00 €
- A** 1 655,00 €
- T** 1 475,00 €

Application variants

Standard: FR

Option: N/A

CLASSIC 064



Available in the following lines:

- U** 2 735,00 €
- AU** 2 410,00 €
- AP** 2 195,00 €
- A** 1 980,00 €
- T** 1 875,00 €

Application variants

Standard: KWL FR

Option: N/A

CLASSIC 072



Available in the following lines:

- U** 2 695,00 €
- AU** 2 375,00 €
- AP** 2 155,00 €
- A** 1 945,00 €
- T** 1 765,00 €

Application variants

Standard: KWL FR

Option: N/A

Application variants on page 21; **Standard** - application included in the price; **Option** - application available at extra charge; **N/A** - application not available.

The prices do not include accessories such as door handles, cylinder locks, pulls and additional charges for non-standard varnishing in two colors and additional charges for making a smooth surface or connecting two different surfaces on one side of the leaf. The prices are net prices and do not include VAT.

STONE COLLECTION

DIPLOMAT B7



Available in the following lines:

U 2 695,00 €

AU 2 375,00 €

AP 2 155,00 €

A 1 945,00 €

Application variants

Standard: **FR** **STONE**

Option: N/A

DIPLOMAT 8E



Available in the following lines:

U 3 095,00 €

AU 2 765,00 €

AP 2 255,00 €

A 2 335,00 €

Application variants

Standard: **KWL** **FR** **STONE**

Option: **ZW** **FR** **STONE**

DIPLOMAT 8W



Available in the following lines:

U 3 095,00 €

AU 2 765,00 €

AP 2 255,00 €

A 2 335,00 €

Application variants

Standard: **KWL** **FR** **STONE**

Option: **ZW** **FR** **STONE**

CRYSTAL COLLECTION

CRYSTAL 01



Available in the following lines:

AU 3 235,00 €

AP 3 020,00 €

Application variants

Standard: **SG** **KWL**

Option: N/A

Did you know?
Your composite door can have an intelligent control system and be integrated with your Smart Home installation. Define your priorities, we will take care of the rest.

VINTAGE COLLECTION

VINTAGE 011



DOOR FRAME IN A DIFFERENT COLOR - OPTIONAL

Available in the following lines:

- U** 3 305,00 €
- AU** 2 985,00 €
- AP** 2 765,00 €

Application variants

Standard: **LM**

VINTAGE 012



Available in the following lines:

- U** 3 235,00 €
- AU** 2 915,00 €
- AP** 2 695,00 €

Application variants

Standard: **LM**

VINTAGE 013



DOOR FRAME IN A DIFFERENT COLOR - OPTIONAL

Available in the following lines:

- U** 3 305,00 €
- AU** 2 985,00 €
- AP** 2 765,00 €

Application variants

Standard: **LM**

VINTAGE 021



DOOR FRAME IN A DIFFERENT COLOR - OPTIONAL

Available in the following lines:

- U** 3 525,00 €
- AU** 3 200,00 €
- AP** 2 985,00 €

Application variants

Standard: **LM**

The VINTAGE collection in the ULTIMATE line is only available in the inward opening version.

Application variants on page 21; **Standard** - application included in the price; **Option** - application available at extra charge; **N/A** - application not available.

The prices do not include accessories such as door handles, cylinder locks, pulls and additional charges for non-standard varnishing in two colors and additional charges for making a smooth surface or connecting two different surfaces on one side of the leaf. The prices are net prices and do not include VAT.

VINTAGE COLLECTION

VINTAGE 031



VINTAGE 032



VINTAGE 111



VINTAGE 121



Available in the following lines:

- U** 3 630,00 €
- AU** 3 305,00 €
- AP** 3 095,00 €

Application variants

Standard: **LM**

Available in the following lines:

- U** 3 705,00 €
- AU** 3 380,00 €
- AP** 3 165,00 €

Application variants

Standard: **LM**

Available in the following lines:

- U** 3 305,00 €
- AU** 2 985,00 €
- AP** 2 765,00 €

Application variants

Standard: **LM**

Available in the following lines:

- U** 3 630,00 €
- AU** 3 305,00 €
- AP** 3 095,00 €

Application variants

Standard: **LM**

Did you know?

Composite doors are available in several dozen sizes in standard versions. On request, they can be produced in any size, up to 2450 mm, and a wide selection of complementary profiles and bands ensure that each solution is comprehensive.

3D COLLECTION

DIPLOMAT 7M



Available in the following lines:

A 2 840,00 €

Application variants

Standard: **3D** **KWL**

Option: N/A

DIPLOMAT C5



Available in the following lines:

A 2 375,00 €

Application variants

Standard: **3D** **FR**

Option: N/A

DIPLOMAT 6K



Available in the following lines:

A 2 950,00 €

Application variants

Standard: **3D** **FR** **KWL**

Option: N/A

DIPLOMAT C6



Available in the following lines:

A 2 375,00 €

Application variants

Standard: **3D** **FR**

Option: N/A

External dimensions of the door from this collection:

- 970 x 2030
- 970 x 2130
- 1070 x 2030
- 1070 x 2130

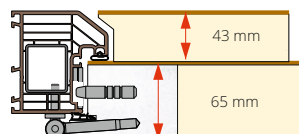

Application variants on page 21; **Standard** - application included in the price; **Option** - application available at extra charge; **N/A** - application not available.

The prices do not include accessories such as door handles, cylinder locks, pulls and additional charges for non-standard varnishing in two colors and additional charges for making a smooth surface or connecting two different surfaces on one side of the leaf. The prices are net prices and do not include VAT.

Haven't found your dream door yet?
Not to worry, let's design it together so you can enjoy aesthetics and functionality tailored to your expectations.

FULL COLOR PALETTE

RAL COLORS IN STANDARD

All composite doors are available in any RAL color.



COLORS WITH 3 SPECIAL EFFECTS



Coating with the GALAXY, PEARL or SAND effect

DON'T FORGET TO MARK THIS IN YOUR ORDER!

Composite doors are varnished in any configuration and color combination (divided into external and internal) and in several colors on each side. Wood-like colors and RAL colors can be combined with each other.



WOOD-LIKE DECORS

For lovers of precious wood colors, we offer one of many decors created by hand by craftsmen of the highest qualifications.



GLAZING PACKAGES - MORE SUN IN YOUR HOME

CHOOSE COMFORT AND SECURITY

Only composite doors offer the possibility to choose glazing decorations from the our wide range with any glass configuration:

- translucent glass: thermofloat
- frosted glass: decormat or sandblasted
- colored translucent glass - antisol brown or antisol graphite
- reflective translucent glass - brown reflex or graphite reflex
- opaque mirror glass - one-way mirror
- patterned glass - ornamental

For increased security and protection against burglary, we recommend combined packages using:

- P2 safety glass.
- P4 anti-burglary glass (only in simple shape packages - square, rectangle)..



BEWEL



PIASKOWANE

SANDBLASTED



ONE-WAY MIRROR



Technologia Żywnicza

DECORMAT



THERMOFLOAT



REFLEX



ANTISOL

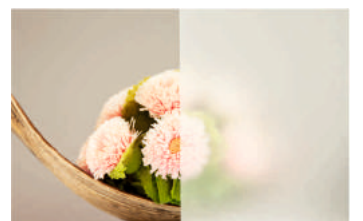

DECORMAT

It is estimated that energy losses due to leakage in the front door may exceed 8% of the cost of heating a single-family home.

By using the innovative technology of structural bonding of three or four-pane packages with the use of warm inter-pane frames in composite doors, we significantly contribute to environmental protection, energy saving and the reduction of heating costs.

Glazing packages in composite doors have super warm glazing frames. This significantly improves their energy efficiency and acoustic comfort. We make glazing packages and stained glass decorations in our own studio, nothing is impossible for us.

Group of decorations	Types of decorations
Group 0	Glazing packages - not decorated
Group I	Decorated glazing and stained glass packages: - engraved - resin decoration - one-way mirror
Group II	Stained glass packages decorated with glued glass elements and elements of inox decorations: - with a bevel and/or inox decoration - with fusing and/or inox decoration - engraved or resin with a bevel and/or inox decoration - engraved or resin with fusing and/or inox decoration
Group III	Stained glass packages for custom orders: - Priva-Lite (glass with variable transparency) - Step Glass (ceramic lacquered glass) - with bevel glass from the Paulo collection - with bevel glass from the Paulina collection - custom orders

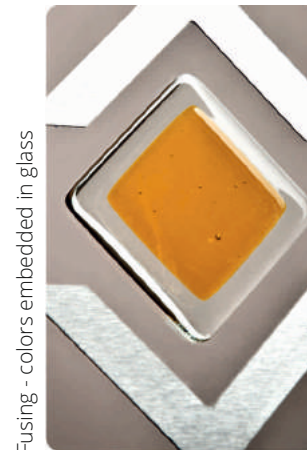

Fusing - colors embedded in glass



Swarovski - jewelry for your door



Bevel glass - the beauty of cut glass



Resin - multitude of colors



LED lighting - a bright accent for your home

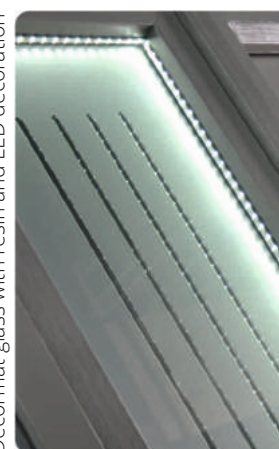

Decorat glass with resin and LED decoration



LED lighting in a package with a one-way mirror

The most beautiful collections of stained glass decorations only in VIKKING composite doors.

REMOTE CONTROLLED DOORS

CHOOSE COMFORT AND SECURITY

Your composite door can be equipped with an intelligent control system and integrated with your Smart Home installation. Don't worry about carrying keys around any more and open your doors in any way you like. You can grant access to any family member. You have full control. Define your priorities, we will take care of the rest.

BIOKEY FINGERPRINT READER



Slide your registered finger on the surface of the reader and your door will automatically open. When you cross the threshold, the door closer will immediately close the leaf and the automatic lock will lock it again.

Keyboard Sorex Unilock



A solution offering the possibility of opening the door using a fingerprint, a keypad with a code, via bluetooth devices (e.g. a smartphone or tablet) and an RFID carrier.

E-key dLine



The system with the ekey dLine fingerprint reader is managed via smartphone or tablet. The new ekey bionyx app developed especially for this purpose can be operated in Comfort mode via the Internet or in Local mode on site via radio.

FORGET ABOUT USING KEYS

TEDEE POWERED BY GERDA



Tedee locking technology powered by GERDA gives you complete remote lock steering. Wherever you are, having a smartphone with internet access, you may check your lock status, see if it is opening or closing. You also can grant access to anyone in that way.



EASY TO INSTALL



SECURITY



FLEXIBILITY

SMART SOLUTIONS FOR YOUR CONVENIENCE

No.	Name	Net price in EURO
1.	Reed switch - door opening sensor	35,00
2.	Electric strike* requires the use of a door closer	140,00
3.	Fixed strike plate* requires the use of a door closer	73,00
4.	Fingerprint (BioKey silver)	835,00
5.	Electronic control in combination with: ! a motorized lock and power supply should be added to the fittings	1 050,00
6.	Keyboard Sorex Unilock	900,00
7.	TEDEE powered by gerda	on request
8.	Power supply for electronic control	18,00
9.	Cylinder locking sensor	130,00

* Doors with a fixed strike plate, electric strike and/or one-sided pull have, in the standard version, a three-point lock, bolted with a cylinder.

RECOMMENDED!



■ Digital peephole DDS1 - 122,00 €

■ Digital peephole DDS2 - 150,00 €
(integrated bell)

Peepholes available in the ARCTIC PLUS, ARCTIC, TOP lines:

■ Wide angle peephole 21,00 €
satin nickel

■ Wide angle peephole 31,00 €
black

CLOSERS



■ GEZE TS 2000 door closer with arm
- the price includes an inox mounting plate
100,00 €

■ GEZE TS 2000 door closer with locking arm
- the price includes an inox mounting plate
130,00 €



■ GEZE TS 3000 door closer (black) with rail
- the price includes an inox mounting plate
206,00 €

■ Opening angle stop for door closer with rail
40,00 €

■ Lock for GEZE 2000 door closer
40,00 €



■ GEZE TS 3000 door closer (silver) with rail
- the price includes an inox mounting plate
200,00 €

■ Opening angle stop for door closer with rail
40,00 €

■ Lock for GEZE 2000 door closer
40,00 €



■ GEZE BOXER door closer with rail
mounted in the door leaf
- the price includes an inox mounting plate
330,00 €

■ Lock for BOXER door closer
85,00 €

WAYS OF OPENING COMPOSITE DOORS

Double-sided handle

Door opened on both sides with a handle.

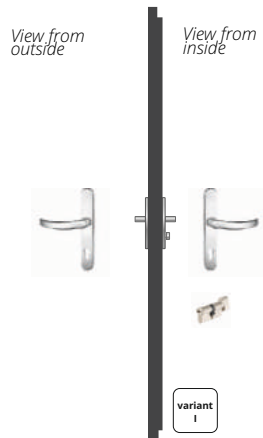

- double-sided handle
- cylinder

Handle-pull

From the inside: open with a door handle
From the outside: open with a key and pull



- one-sided pull
- one-sided plate
- one-sided handle
- cylinder

Handle-pull with fixed strike plate

From the inside: open with a door handle
From the outside: during the day: use the door pull;
at night: open using the key and use the door pull. We recommend using a door closer.



- one-sided pull
- one-sided plate
- one-sided handle
- cylinder
- fixed strike plate (day and night)
- door closer

Handle-pull with electric strike

From the inside: open with a door handle
From the outside: during the day: use the door pull;
at night: open using the key and use the door pull; optionally: control using intercom.
We recommend using a door closer.



- one-sided pull
- one-sided plate
- one-sided handle
- cylinder
- electric strike (without control)
- door closer

Handle-pull with microswitch

From the inside: open with a door handle
From the outside: press the micro switch in the pull
and open the door. We recommend using a door closer.

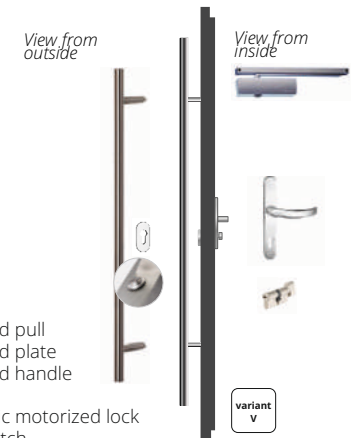

- one-sided pull
- one-sided plate
- one-sided handle
- cylinder
- automatic motorized lock
- microswitch
- power supply
- door closer

Handle-pull with sensor

From the inside: open with a door handle
From the outside: press the sensor in the pull
and open the door. We recommend using a door closer.



- one-sided pull
- one-sided plate
- one-sided handle
- cylinder
- automatic motorized lock
- sensor
- power supply
- door closer

Handle-pull with a fingerprint reader

From the inside: open with a door handle
From the outside: scan your finger on the reader
and open the door. The system remembers max.
150 fingerprints. We recommend using a door closer.



- one-sided pull
- one-sided plate
- one-sided handle
- cylinder
- automatic motorized lock
- fingerprint reader
- power supply
- door closer

Handle-pull with a Bluetooth keyboard

From the inside: open with a door handle
From the outside: enter the code on the keyboard
and open the door. The system remembers max. 18 codes
and 6 smartphones. We recommend using a door closer.

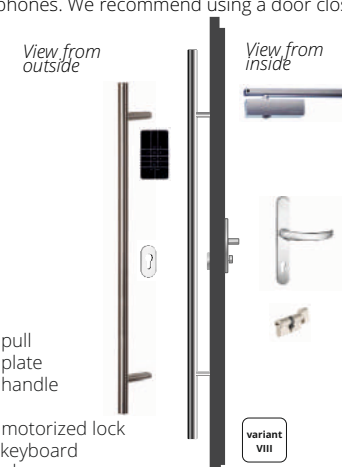

- one-sided pull
- one-sided plate
- one-sided handle
- cylinder
- automatic motorized lock
- Bluetooth keyboard
- power supply
- door closer

Handle-pull RFID (key fob control)

From the inside: open with a door handle
From the outside: scan the code with the key ring
and open the door. The system remembers max. 150 cards
or key rings. We recommend using a door closer.



- one-sided pull
- one-sided plate
- one-sided handle
- cylinder
- automatic motorized lock
- RFID
- power supply
- door closer

STRIP LOCKS AND ACCESSORIES

Strip locks for doors in the
ULTIMATE, ARCTIC ULTRA, ARCTIC PLUS, ARCTIC, TOP lines

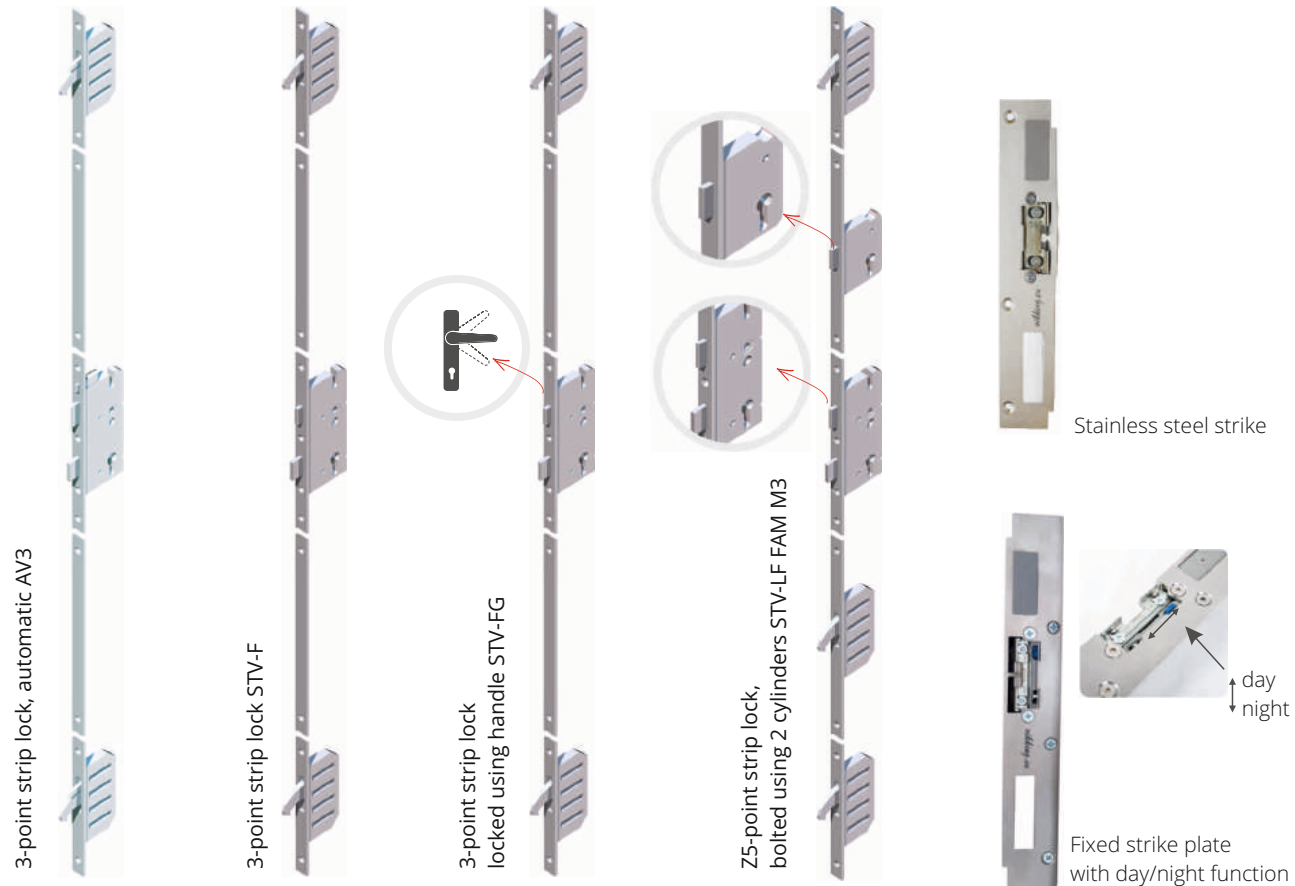

Multi-point locks from leading manufacturers protecting the safety of your loved ones.

With electric strikes and fixed strike plates it is recommended to use a door closer that will protect the leaf against opening due to draft.

HANDLES



Lord door handle reinforced with concealed screws double-sided

white, brown	50,00 €
F4 old gold F9 satin nickel	58,00 €
stainless steel	142,00 €



Baron door handle reinforced with concealed screws double-sided

white, brown	50,00 €
F4 old gold F9 satin nickel	58,00 €
black	62,00 €
stainless steel	142,00 €



Baron or Lord plate, oval or rectangular (double-sided) dedicated to an additional upper lock

white, brown	18,00 €
F4 old gold F9 satin nickel	20,00 €
black	24,00 €
stainless steel	55,00 €



Lord door handle reinforced with concealed screws with cylinder protection - double-sided

F4 old gold F9 satin nickel	103,00 €
--------------------------------	----------



Baron door handle reinforced with concealed screws with cylinder protection - double-sided

F4 old gold F9 satin nickel	102,00 €
--------------------------------	----------



Baron or Lord plate (oval) with cylinder protection from the external side (double-sided) dedicated to an additional upper cylinder

F4 old gold F9 satin nickel	38,00 €
--------------------------------	---------



Haga Plus handle - double-sided

F8 black	55,00 €
F6 inox cut F4 old gold	53,00 €



Haga Plus handle-knob

F8 black	62,00 €
F6 inox cut F4 old gold	57,00 €



Haga Plus plate¹ - double-sided

F8 black	21,00 €
F6 inox cut F4 old gold	18,00 €



Niagara Plus handle double-sided

F6 inox cut F4 old gold	50,00 €
----------------------------	---------



AXA Niagara Plus plate¹

F6 inox cut F4 old gold	18,00 €
----------------------------	---------



Prestige handle, class III double-sided

F6 inox cut F4 old gold	88,00 €
----------------------------	---------



Prestige plate, class III¹

F6 inox cut F4 old gold	50,00 €
----------------------------	---------



Prestige handle, class III with cylinder protection - double-sided

F8 black	112,00 €
F6 inox cut F4 old gold	98,00 €



Prestige plate, class III¹ with cylinder protection - double-sided

F8 black	65,00 €
F6 inox cut F4 old gold	58,00 €



Odin handle, class III double-sided

inox polished F4 old gold	86,00 €
------------------------------	---------



Odin handle-knob class III

inox polished F4 old gold	92,00 €
------------------------------	---------



Odin plate, class III double-sided

inox polished F4 old gold	45,00 €
------------------------------	---------



Mars* handle with a divided plate for the cylinder

F8 black	100,00 €
F6 inox cut F4 old gold	92,00 €



Mars Flex* handle with a divided plate with cylinder protection

F8 black	128,00 €
F6 inox cut F4 old gold	115,00 €



Mars* Handle-knob with a divided plate for the cylinder

F8 black	120,00 €
F6 inox cut F4 old gold	105,00 €

All net prices (VAT should be added)

¹ Applies to doors equipped with an additional upper lock

*only available in the ULTIMATE line

PULLS



Round pull
one-sided bow
P45B

L= 580 mm	100,00 €
L= 870 mm	222,00 €

Round pull
one-sided bow
P10B

L= 1650 mm	260,00 €
------------	----------

KP pull
rectangular bow
one-sided

L= 1750 mm	260,00 €
------------	----------

One-sided round pull
P45 - slanting brackets
P10 - straight brackets

L= 580 mm	80,00 €
L=1000 mm	105,00 €
L=1200 mm	125,00 €
L=1400 mm	145,00 €
L=1600 mm	165,00 €
L=1800 mm	180,00 €

Rectangular pull 40x20, one-sided
Q45 - slanting brackets
Q10 - straight brackets

L= 580 mm	100,00 €
L=1000 mm	125,00 €
L=1200 mm	145,00 €
L=1400 mm	165,00 €
L=1600 mm	190,00 €
L=1800 mm	200,00 €

ONE-SIDED HANDLES DEDICATED TO INOX AND BLACK VARNISHED HANDLES



Lord handle
one-sided for pulls

F9 satin nickel	34,00 €
-----------------	---------



Baron handle
one-sided for pulls

F9 satin nickel	34,00 €
black	36,00 €



oval rectangular

Baron plate
one-sided for door handles and pulls

F9 satin nickel	10,00 €
black	12,00 €



One-sided oval plate
with cylinder protection
dedicated to inox door handles and pulls

F9 satin nickel	25,00 €
-----------------	---------

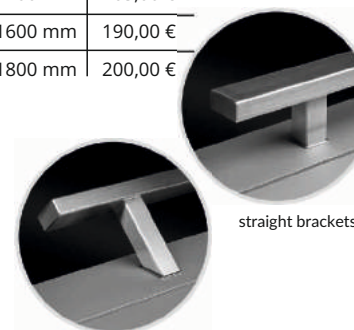

straight brackets

slanting brackets

NEW 2022

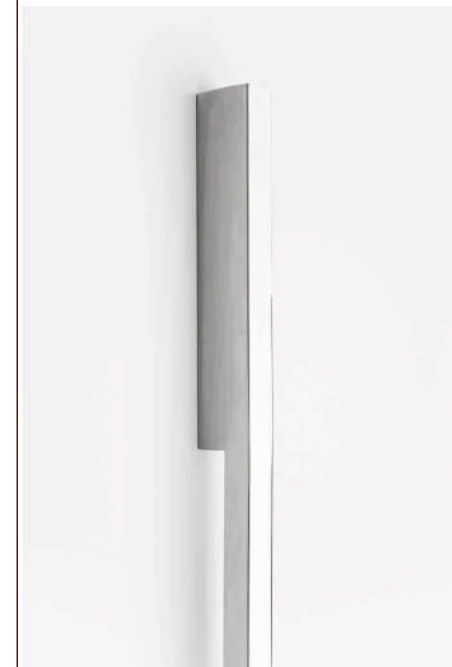

LONG-C

Pull LONG-C to the size of leaf

L= 1800 mm - 2400 mm

500,00 €

inox/cut	500 €
black	500 €

PULLS



K1 long flush pull
one-sided
mounted in the door leaf
width 155 mm / height 550 mm

varnished aluminum in black	360,00 €
inox	360,00 €

K1 LONG



KA1-61x2000 aluminum pull,
black, varnished
with built-in LED strip
mounted in the door leaf
(power supply must be added)

L= 1600 mm -	450,00 €
L= 2000 mm -	500,00 €

KA1



Pochwył PS-W
one-sided
inox

L= 1800 mm	528,00 €
L= 2000 mm	542,00 €
L=2200 mm	555,00 €

PS-W



Pochwył PS
one-sided
width 100 mm

L= 1800 mm	450,00 €
L= 2000 mm	470,00 €
L=2200 mm	480,00 €

PS



AMSTERDAM

Amsterdam pull
one-sided , rectangular

inox cut F4 old gold		F8 black	
L= 800 mm	167,00 €	L= 800 mm	195,00 €
L=1200 mm	186,00 €	L=1200 mm	213,00 €
L=1500 mm	195,00 €	L=1500 mm	222,00 €
L=1700 mm	200,00 €	L=1700 mm	228,00 €

Optional

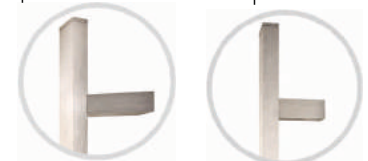

slanting brackets straight brackets

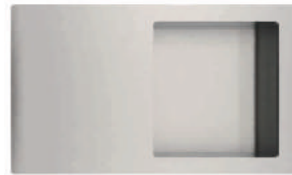

K1 SHORT

K1 short flush pull
one-sided
mounted in the door leaf
width 250 mm/ height 150 mm

varnished aluminum in black	300,00 €
inox	300,00 €



Qa90 pull, square tube 40x40
one-sided
inox lub varnished aluminum
in black (other RAL colors on request)

L= 800 mm	
L= 1000 mm	167,00 €
L= 1200 mm	
L= 1400 mm	
L= 1600 mm	195,00 €
L= 1800 mm	

QA90



NEW

Pull MONTREAL one around
black (straight brackets)

L= 800 mm	155,00 €
L=1200 mm	165,00 €
L=1500 mm	170,00 €
L=1700 mm	180,00 €

ONE-SIDED HANDLES DEDICATED TO INOX AND BLACK VARNISHED HANDLES



Lord handle
one-sided for pulls

F9 satin nickel	35,00 €
-----------------	---------



Baron handle
one-sided for pulls

F9 satin nickel	35,00 €
black	36,00 €



Baron plate
one-sided for door handles and pulls

F9 satin nickel	10,00 €
black	12,00 €



One-sided oval plate
with cylinder protection
dedicated to inox door handles and pulls

F9 satin nickel	25,00 €
-----------------	---------

ONE-SIDED HANDLES DEDICATED TO AMSTERDAM HANDLES



One-sided Solo handle
with one-sided plate dedicated
to pulls AMSTERDAM

F8 black	58,00 €
F6 inox cut F4 old gold	53,00 €

Two-sided upper Solo plate³

F8 black	30,00 €
F6 inox cut F4 old gold	28,00 €

Cylinders

Cylinders from the ARCTIC ULTRA and ULTIMATE lines			
No.	Name	color	Net price in EURO
1.	Key/key cylinder - C class 	nickel	75,00
2.	Key/key cylinder - C class	black	85,00
3.	Key/knob cylinder - C class 	nickel	80,00
4.	Key/knob cylinder - C class	black	95,00
5.	One key system cylinder (key/key + key/knob) C class 	nickel	140,00
6.	One key system cylinder (key/key + key/knob) C class	black	156,00
Cylinders from the ARCTIC PLUS, ARCTIC and TOP lines			
7,	Key/key cylinder - standard 	nickel	19,00
8.	Key/knob cylinder - standard 	nickel	23,00
9.	Key/key cylinder - C class 	nickel or brass	70,00
10.	Key/knob cylinder - C class 	nickel or brass	75,00
11.	One key system cylinder (key/key + key/knob) C class	nickel	125,00

Pulls with electronics mounted in the leaf and connected.

Electronics available in selected models.



Microswitch in the pull (does not apply to bow pulls)
The price includes cable gland installation: leaf - frame
It is recommended to add an electric strike and a power supply* 305,00 €

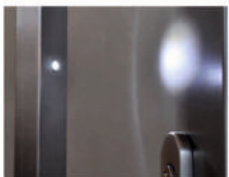

Microswitch in the pull (does not apply to bow pulls)
It is recommended to add a motorized lock with a cable gland and power supply* 155,00 €

Spot "LED" lighting dedicated to pulls.
The price includes a complete installation with 2 pin. connector plug: leaf - frame
does not apply to bow pulls
first point 75,00 €
second point 30,00 €

NEW

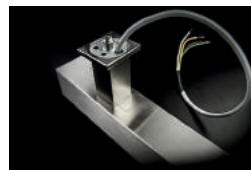

In the past, cables from the fingerprint reader, numeric keypad or touch sensor, and any other available electronics, would stick out of doors, curl up, be too long, and require repeated cutting and soldering.
From now on, these experiences will disappear thanks to the revision in the handles, which makes it possible hiding the excess cable in the holder **

	Electric strike	140,00 €
*	Motorized lock with a cable gland	540,00 €
	Door pull power supply - 2.5 A	18,00 €
**	Pulls P45, P10, Q45, Q10	30,00 €

Did you know?

Pull can be equipped with functionalities facilitating the use of the door.
Discreet LED lighting, a fingerprint reader, sensor or button releasing the catch in the door frame - these are solutions that increase comfort of use.

MATCHING DIMENSIONS

No.	Name	ULTIMATE	ARCTIC ULTRA	ARCTIC PLUS	ARCTIC	TOP	Net price in EURO	unit
1.	XXL size doors height H1 = from 2230 mm to 2430 mm, in 50 mm increments applies to dimensions marked in the dimension table with a different color	O	O	O	O	N/A	280,00	Set
2.	Doors in MINI size – applies to dimensions smaller than those in the dimension table	O	O	O	O	N/A	170,00	Set
3.	Modification of standard dimensions ¹ shortening or narrowing to any height and width from the dimensions in the size table	O	O	O	O	N/A	170,00	Set
4.	PVC frame extension with steel reinforcements decorated or varnished in the color of the frame	15 mm / per side (does not include reinforcements)	N/A	O	O	O	17,00	mb
5.		35 mm / per side	N/A	O	O	O	28,00	mb
6.		60 mm / per side	N/W	O	O	O	40,00	mb
7.		100 mm / per side	N/A	O	O	O	62,00	mb
8.	Expanding the composite door frame in the ULTIMATE line	20 mm	O	N/A	N/A	N/A	22,00	mb
9.		40 mm	O	N/A	N/A	N/A	37,00	mb
10.		60 mm	O	N/A	N/A	N/A	55,00	mb

BANDING STRIPS

No.	Name	ULTIMATE	ARCTIC ULTRA	ARCTIC PLUS	ARCTIC	TOP	Net price in EURO	unit
11.	30 mm x 8 mm PVC banding strip smooth surface or decorated real wood varnished in the color of the door frame – length adapted to the door size rounded to 0.5 mb upwards	N/A	O	O	O	O	15,00	mb
12.	50 mm x 12 mm PVC banding strip smooth surface or decorated real wood varnished in the color of the door frame – length adapted to the door size rounded to 0.5 mb upwards	N/A	O	O	O	O	23,00	mb
13.	"LGK" masking strip in the color of the frame L=6 mb smooth surface in the color of the door frame – (available only in the "SMOOTH" surface) length adapted to the door size rounded to 0.5 mb upwards	N/A	O	O	O	O	14,00	mb
14.	60mm x 10mm meranti banding strips (other sizes available on request)	O	O	O	O	O	20,00	mb

Legend
S - standard version
no extra charge,
O - optional at extra charge,
N/A - not available,

THRESHOLD ADDITIONS

Lp.	Nazwa		ULTIMATE	ARCTIC ULTRA	ARCTIC PLUS	ARCTIC	TOP	Net price in EURO	jm
15.	Sub-threshold PVC profile without steel reinforcement	30 mm	N/W	O	O	O	O	20,00	mb
16.		65 mm	N/W	O	O	O	O	30,00	mb
17.	ub-threshold PVC profile with steel reinforcement	30 mm	N/W	O	O	O	O	27,00	mb
18.		65 mm	N/W	O	O	O	O	39,00	mb
19.	Thermal sub-threshold profile 1 pc. = 1.15 m	70 mm	O	N/W	N/W	N/W	N/W	58,00	pcs.
20.		90 mm	O	N/W	N/W	N/W	N/W	66,00	pcs.
21.		110 mm	O	N/W	N/W	N/W	N/W	75,00	pcs.
22.		130 mm	O	N/W	N/W	N/W	N/W	81,00	pcs.
23.		150 mm	O	N/W	N/W	N/W	N/W	90,00	pcs.
24.		170 mm	O	N/W	N/W	N/W	N/W	103,00	pcs.
25.		200 mm	O	N/W	N/W	N/W	N/W	117,00	pcs.
26.		250 mm	O	N/W	N/W	N/W	N/W	155,00	pcs.
27.	300 mm	O	N/W	N/W	N/W	N/W	173,00	pcs.	
28.	Profile SUPERFIX glue		O	O	O	O	O	15,00	pcs.
29.	Automatic door seal		O	O	O	O	N/W	53,00	pcs.
30.	NT" threshold leveling pad		N/W	O	O	O	O	27,00	pcs.

SUB-THRESHOLD PROFILES

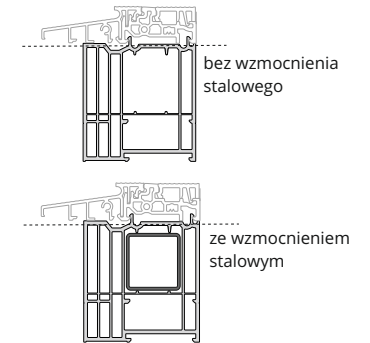

AUTOMATIC DOOR SEAL

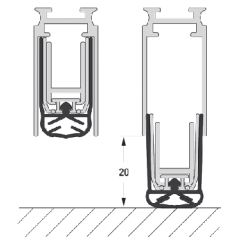

THRESHOLD LEVELING PAD

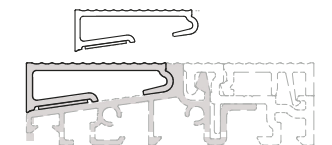

LOCKS

No.	Name	ULTIMATE	ARCTIC ULTRA	ARCTIC PLUS	ARCTIC	TOP	Net price in EURO	unit
31.	Extra charge for a three-point strip lock with automatic locking	S	S	S	O	O	110,00	set
32.	Extra charge for a strip lock bolted with two cylinders	O	O	O	O	N/A	130,00	set
33.	Extra charge for a motorized lock with a cable gland	O	O	O	O	N/A	545,00	set
34.	Anti-burglary bolts	S	S	S	S	O	55,00	set

EXTREME DOOR DRIP



Legend
 S - standard version
 no extra charge,
 O - optional at extra charge,
 N/A - not available,

OTHER

No.	Name	ULTIMATE	ARCTIC ULTRA	ARCTIC PLUS	ARCTIC	TOP	Net price in EURO	unit
35.	Extra charge for rebated doors in combination with 85 mm x 75 mm meranti door frame	N/A	O	O	O	N/A	165,00	set
36.	Complete double door	O	O	O	O	N/A	twice the price of the model with the active wing	
37.	Illuminated door leaf - LED lighting mounted in the rebate from the bottom of the leaf The price includes a complete installation with 2 pin. connector plug: leaf-frame	the price does not include the power supply, see item 69-71	O	O	O	N/A	175,00	pcs.
38.	Extra charge for additional silicone peripheral seal of the leaf (third)	N/A	S	S	O	O	55,00	pcs.
39.	Door drip, varnished in the color of the door (applies to external doors that open inwards)	O	O	O	O	O	25,00	pcs.
40.	Extreme door drip in threshold color (anodized aluminum)	O	O	O	O	O	30,00	pcs.

CUSTOM SURFACES

No.	Name	ULTIMATE	ARCTIC ULTRA	ARCTIC PLUS	ARCTIC	TOP	Net price in EURO	unit	
41.	SMOOTH surface finish	one-sided	O	O	O	O	N/A	50,00	set
42.		two-sided	O	O	O	O	N/A	100,00	set
43.	Doors with combined SMOOTH and RW surfaces (on one side of the leaf)		O	O	O	O	N/A	150,00	set
44.	SMOOTH surface in ULTIMATE sidelights applies to composite panel filling – PORTAL	one-sided	O	N/A	N/A	N/A	N/A	46,00	set
45.		two-sided	O	N/A	N/A	N/A	N/A	92,00	set
46.	Additional charge for varnishing in non-standard colors including: metallic, fluorescent, as well as with a gloss level above 40 (semi-gloss and gloss)* Varnish with pearl effect – option without additional charge – available in all lines on RW and SMOOTH surfaces – in RAL colors and wood-like decors GALAXY and SAND powder coating varnish – option without additional charge – available only on SMOOTH surface and in RAL colors PLEASE NOTE! Precisely specify the type of coating in the order.	doors	O	O	O	O	N/A	250,00	set
47.		portals and sidelights	O	O	O	O	N/A	140,00	pcs.
48.	Additional charge for varnishing in wood-like decors	doors	S	S	S	S	O	110,00	set
49.		portals and sidelights	S	S	S	S	O	55,00	pcs.
50.	Additional charge for varnishing in two colors	doors	O	O	O	O	O	140,00	set
51.		portals and sidelights	O	O	O	O	O	75,00	pcs.
52.	Additional charge for the third and each additional color (additional charge does not apply to KZ and KW frames)		O	O	O	O	N/A	105,00	set
53.	Additional charge for varnishing due to the complex division of colors		O	O	O	O	N/A	on request	
54.	Additional charge for varnishing KZ and KW frames in a different color		O	O	O	O	N/A	70,00	set
55.	House door number	inox flush digits height 140 mm	O	O	O	O	O	55,00	1 digit
56.		semi-flush composite board digits	O	O	O	O	O	55,00	1 digit
57.	FL decorative inox strips – flush with the leaf surface (available only in straight lines)	one-sided	O	O	O	O	O	55,00	set
58.	FR application from the inside of the leaf – milled decoration		O	O	O	O	O	92,00	set
59.	Inox or composite frames - both sides (RZ + RZ or KZL + KWL)		O	O	O	O	O	115,00	set
60.	STONE application	calculated not less than 0.2 m2	O	O	O	O	N/A	585,00	m ²
61.	Inlay – decoration of the door with a semi-flush application from a composite board		O	O	O	O	N/A	on request	
62.	Frameless ZW system (glazing flushed on both sides) in the leaf		O	O	O	O	N/A	360,00	set
63.	"LC" inox threshold strip, 90 mm high – other sizes on request.		O	O	O	O		36,00	pcs.

GLAZING AND WINDOW DECORATIONS

No.	Name	ULTIMATE	ARCTIC ULTRA	ARCTIC PLUS	ARCTIC	TOP	Net price in EURO	unit		
64.	Glazing class P2 – in the leaf	O	O	O	O	O	70,00	set		
65.	Glazing class P4 – in the leaf (not available in arched glazing)	O	O	O	O	N/A	110,00	set		
66.	Glazing class P2 – in sidelights (min. size calculated at 0.4 m2)	O	O	O	O	O	110,00	m ²		
67.	Glazing class P4 – in sidelights (min. size calculated at 0.4 m2)	O	O	O	O	N/A	220,00	m ²		
68.	Glazing and stained glass packages in the door leaf see Stained Glass Catalog www.vikking.eu/download Decorations of glazing in sidelights – see table on page 71	group I patterns or packages with one-way mirror		S	S	S	S	O	70,00	set
69.		group II patterns		S	S	O	O	N/A	160,00	set
70.		group III patterns - custom designs		O	O	O	O	N/A	on request	
71.	House number – digits on the glazing made using resin technology		O	O	O	O	O	55,00	1 digit	
72.	LED lighting in the door glazing. * The price includes a complete installation with a contact connector: leaf - frame	the price does not include the power supply see items 69-71		O	O	O	O	N/A	305,00	set
73.	LED lighting in the sidelight glazing			O	O	O	O	N/A	160,00	mb
74.	Power supply (2,5A) for LED lighting in the door leaf	O	O	O	O	N/A	18,00	pcs.		
75.	Power supply (4A) for LED lighting in the door leaf and sidelight	O	O	O	O	N/A	21,00	pcs.		
76.	Power supply (1.67A) for flush-mounted box	O	O	O	O	O	25,00	pcs.		

GLAZING IN PRIVA-LITE TECHNOLOGY

No.	Name	ULTIMATE	ARCTIC ULTRA	ARCTIC PLUS	ARCTIC	TOP	Net price in EURO	unit		
77.	Glazing with Priva-Lite glass in the leaf	O	O	O	O	N/A	720,00	pcs.		
78.	Glazing with Priva-Lite glass in sidelight	min. size calculated at 0.4 m2 to 1m ²		O	O	O	O	N/A	1538,00	m ²
79.		the size is calculated from 1m2 to 2m2		O	O	O	O	N/A	1440,00	m ²
80.		the size is calculated from 2m2		O	O	O	O	N/A	1360,00	m ²
81.	Bluetooth controller – remote control for the PrivaLite glazing	O	O	O	O	N/A	250,00	set		
82.	Single C-line touch switch with remote control	O	O	O	O	N/A	60,00	pcs.		
83.	Power supply for the set (48V)	O	O	O	O	N/A	50,00	pcs.		

Glazing with the electronic control of variable translucency are available only in rectangular shapes.

Legend
 S - standard version- no extra charge,
 O - optional at extra charge,
 N/A - not available,
 * Not available with the ZW frameless system
ATTENTION: damage to individual LED lighting points (max. up to 10%) is not subject to warranty claims.

SIDELIGHTS

PERFECTLY MATCHED TO YOUR HOUSE

The possibility of adding sidelights and transom lights in any configurations, sizes and shapes.

Sidelights and transom lights are a great idea for more daylight in the interior. They are perfect for full doors.

The sidelights can be filled with:

- glazing with any decorations
- composite panel

In the ULTIMATE line, thanks to the combination with a composite door frame, the sidelight system is constructed without visible connecting profiles.

In the remaining lines, the sidelight construction is based on a system of static connectors ensuring stability of the structure.

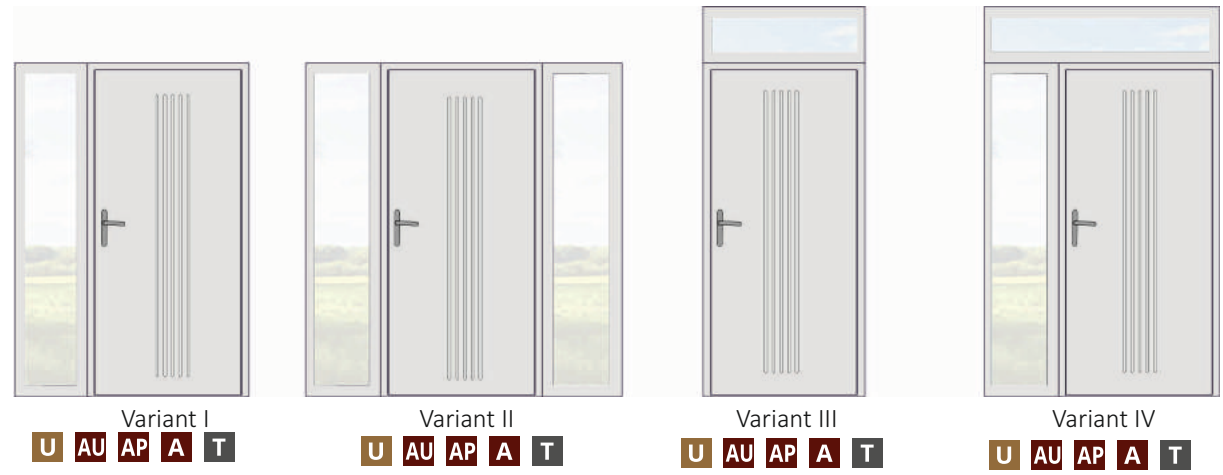
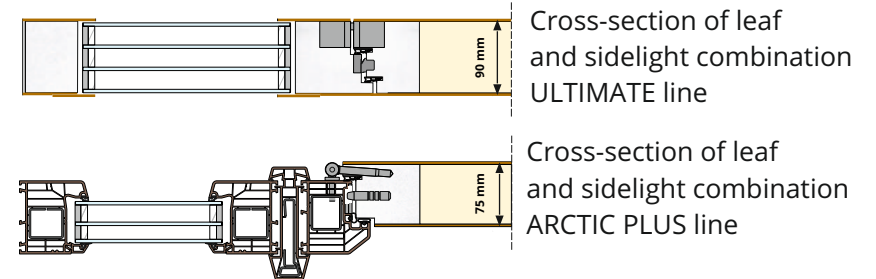
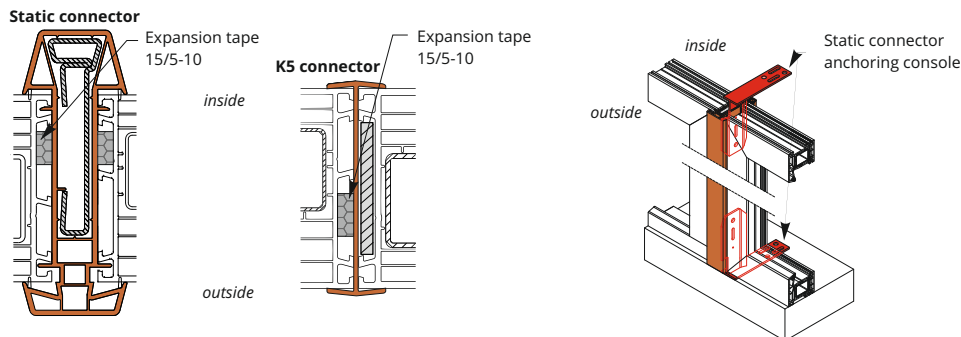

Diagram of connectors used in the lines: AU AP A T



PORTALS AND SIDELIGHTS

Price list for portals and sidelights

Height according to the height of the door; no higher than 2180 mm; higher than 2180 mm = 20% extra charge.		PORTALS*	SIDELIGHTS						
			Sidelight width		Composite panel filling	Filling with glazing from the "0" group		Filling with glazing from the "I" group or glazing with a one-way mirror	
Top, Arctic, Arctic Plus, Arctic Ultra	Ultimate	Ultimate	Arctic, Arctic Plus, Arctic Ultra	Top, Arctic, Arctic Plus, Arctic Ultra	Ultimate	Top, Arctic, Arctic Plus, Arctic Ultra	Ultimate	Arctic, Arctic Plus, Arctic Ultra	Ultimate
250mm; 300mm; 350mm; 400mm	300mm; 350mm; 400mm	from 1 005,00 €	575,00 €	540,00 €	1 260,00 €	615,00 €	1 315,00 €	680,00 €	1 360,00 €
450mm; 500mm; 550mm; 600mm		from 1 145,00 €	715,00 €	615,00 €	1 470,00 €	720,00 €	1 550,00 €	780,00 €	1 585,00 €
650mm; 700mm; 750mm; 800mm; 850mm**		from 1 295,00 €	940,00 €	795,00 €	1 725,00 €	860,00 €	1 800,00 €	975,00 €	1 905,00 €

Price list for portals and transom lights

Width according to the width of the door; no wider than 1160 mm (Ultimate 1170 mm); width greater than 1160 mm (Ultimate 1170 mm) - see sidelight table		PORTALS*	SIDELIGHTS						
			Transom light height		Composite panel filling	Filling with glazing from the "0" group		Filling with glazing from the "I" group or glazing with a one-way mirror	
Top, Arctic, Arctic Plus, Arctic Ultra	Ultimate	Ultimate	Arctic, Arctic Plus, Arctic Ultra	Top, Arctic, Arctic Plus, Arctic Ultra	Ultimate	Top, Arctic, Arctic Plus, Arctic Ultra	Ultimate	Arctic, Arctic Plus, Arctic Ultra	Ultimate
250mm; 300mm; 350mm; 400mm	300mm; 350mm; 400mm	from 605,00 €	350,00 €	325,00 €	760,00 €	370,00 €	790,00 €	420,00 €	820,00 €
450mm; 500mm; 550mm; 600mm		from 820,00 €	430,00 €	370,00 €	890,00 €	430,00 €	930,00 €	500,00 €	945,00 €
650mm; 700mm; 750mm; 800mm; 850mm**		from 1070,00 €	560,00 €	480,00 €	1040,00 €	525,00 €	1080,00 €	600,00 €	1 145,00 €

Note: in the case of a non-standard size of the opening, we recommend the use of profiles widening the door frame or sidelight frame, extra charge: see page 66, items 4-10

Extra charge for a glazing bar in the sidelight - 40,00 €

Portal or sidelight in a custom size between standard sidelight dimensions - option for extra charge - 150,00 €

Portals and sidelights larger than the maximum standard dimensions - extra charge of 20%

The above-mentioned prices include one complete portal or sidelight and contain a set of installation elements and anchors - in a quantity according to the factory standard.

Note: in the TOP, ARCTIC, ARCTIC PLUS and ARCTIC ULTRA door lines the dimension and price of the sidelight and transom light include a static connector and a console set.

Dimensions of portals and sidelights are calculated from the standard door size

Note: sidelights with glazing in the P2 or P4 class - additional charge: see page 69, item 61-62

* detailed pricing on request

** other sidelight sizes - detailed pricing on request.

ULTIMATE

		The height of the opening in the wall H2								
		2100	2150	2200	2250	2300	2350	2400	2450	
The width of the opening in the wall S2	1000	frame external dim.	970 x 2080	970 x 2130	970 x 2180	970 x 2230	970 x 2280	970 x 2330	970 x 2380	970 x 2430
		frame internal dim.	802 x 1976	802 x 2026	802 x 2076	802 x 2126	802 x 2176	802 x 2226	802 x 2276	802 x 2326
	1050	frame external dim.	1020 x 2080	1020 x 2130	1020 x 2180	1020 x 2230	1020 x 2280	1020 x 2330	1020 x 2380	1020 x 2430
		frame internal dim.	852 x 1976	852 x 2026	852 x 2076	852 x 2126	852 x 2176	852 x 2226	852 x 2276	852 x 2326
	1100	frame external dim.	1070 x 2080	1070 x 2130	1070 x 2180	1070 x 2230	1070 x 2280	1070 x 2330	1070 x 2380	1070 x 2430
		frame internal dim.	902 x 1976	902 x 2026	902 x 2076	902 x 2126	902 x 2176	902 x 2226	902 x 2276	902 x 2326
	1150	frame external dim.	1120 x 2080	1120 x 2130	1120 x 2180	1120 x 2230	1120 x 2280	1120 x 2330	1120 x 2380	1120 x 2430
		frame internal dim.	952 x 1976	952 x 2026	952 x 2076	952 x 2126	952 x 2176	952 x 2226	952 x 2276	952 x 2326
	1200	frame external dim.	1170 x 2080	1170 x 2130	1170 x 2180	1170 x 2230	1170 x 2280	1170 x 2330	1170 x 2380	1170 x 2430
		frame internal dim.	1002 x 1976	1002 x 2026	1002 x 2076	1002 x 2126	1002 x 2176	1002 x 2226	1002 x 2276	1002 x 2326
	1250	frame external dim.	1220 x 2080	1220 x 2130	1220 x 2180	1220 x 2230	1220 x 2280	1220 x 2330	1220 x 2380	1220 x 2430
		frame internal dim.	1052 x 1976	1052 x 2026	1052 x 2076	1052 x 2126	1052 x 2176	1052 x 2226	1052 x 2276	1052 x 2326

ARCTIC ULTRA, ARCTIC PLUS, ARCTIC, TOP

		The height of the opening in the wall H2									
		2050	2100	2150	2200	2250	2300	2350	2400	2450	
The width of the opening in the wall S2	950	frame external dim.	920 x 2030	920 x 2080	920 x 2130	920 x 2180	920 x 2230	920 x 2280	920 x 2330	920 x 2380	920 x 2430
		frame internal dim.	760 x 1930	760 x 1980	760 x 2030	760 x 2080	760 x 2130	760 x 2180	760 x 2230	760 x 2280	760 x 2330
	1000	frame external dim.	970 x 2030	970 x 2080*	970 x 2130*	970 x 2180	970 x 2230	970 x 2280	970 x 2330	970 x 2380	970 x 2430
		frame internal dim.	810 x 1930	810 x 1980*	810 x 2030*	810 x 2080	810 x 2130	810 x 2180	810 x 2230	810 x 2280	810 x 2330
	1050	frame external dim.	1020 x 2030*	1020 x 2080*	1020 x 2130*	1020 x 2180*	1020 x 2230	1020 x 2280	1020 x 2330	1020 x 2380	1020 x 2430
		frame internal dim.	860 x 1930*	860 x 1980*	860 x 2030*	860 x 2080*	860 x 2130	860 x 2180	860 x 2230	860 x 2280	860 x 2330
	1100	frame external dim.	1070 x 2030*	1070 x 2080*	1070 x 2130*	1070 x 2180*	1070 x 2230	1070 x 2280	1070 x 2330	1070 x 2380	1070 x 2430
		frame internal dim.	910 x 1930*	910 x 1980*	910 x 2030*	910 x 2080*	910 x 2130	910 x 2180	910 x 2230	910 x 2280	910 x 2330
	1150	frame external dim.	1120 x 2030	1120 x 2080	1120 x 2130	1120 x 2180	1120 x 2230	1120 x 2280	1120 x 2330	1120 x 2380	1120 x 2430
		frame internal dim.	960 x 1930	960 x 1980	960 x 2030	960 x 2080	960 x 2130	960 x 2180	960 x 2230	960 x 2280	960 x 2330
	1200	frame external dim.	1170 x 2030	1120 x 2080	1120 x 2130	1120 x 2180	1170 x 2230	1120 x 2280	1120 x 2330	1120 x 2380	1120 x 2430
		frame internal dim.	1010 x 1930	1010 x 1980	1010 x 2030	1010 x 2080	1010 x 2130	1010 x 2180	1010 x 2230	1010 x 2280	1010 x 2330
	1250	frame external dim.	1220 x 2030	1120 x 2080	1120 x 2130	1120 x 2180	1220 x 2230	1120 x 2280	1120 x 2330	1120 x 2380	1120 x 2430
		frame internal dim.	1060 x 1930	1060 x 1980	1060 x 2030	1060 x 2080	1060 x 2130	1060 x 2180	1060 x 2230	1060 x 2280	1060 x 2330

Non-standard sizes (marked with a colored background) – optional, at extra charge, see page 66

Dimensional tolerance according to PN: up to 1m: +/- 1mm; above 1m: +/- 2mm

*Dimensions available in the TOP line

Non-standard sizes of doors, portals and sidelights are available optionally, pricing on request.

Optional frame extensions as well as a system of banding strips and grilles are available for all door models and sidelights.

Do you need technical support, a visualization or an individual design? Contact us at: wyceny@vikking.eu

PROFESSIONAL INSTALLATION – GUARANTEE OF QUALITY AND COMFORT OF USE

Door dimensioning diagram

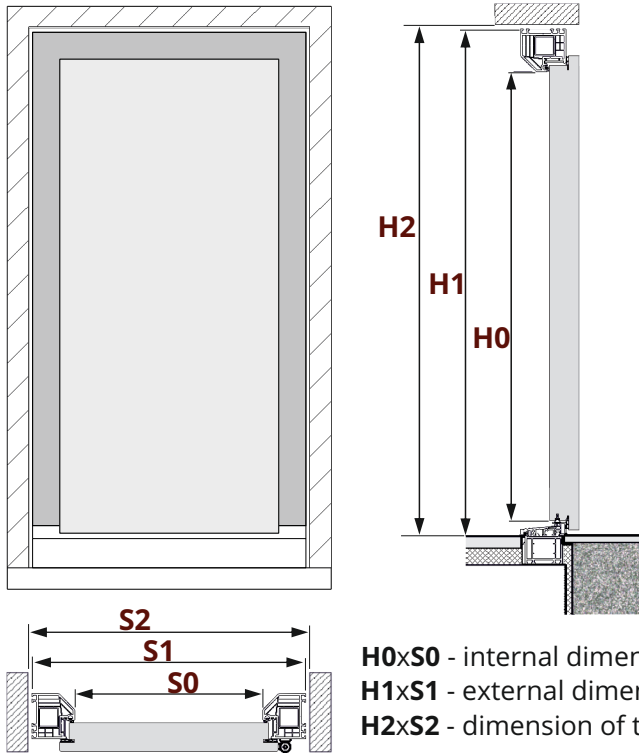

H0xS0 - internal dimension of the frame
H1xS1 - external dimension of the frame
H2xS2 - dimension of the opening in the wall

Do not require an overhang!

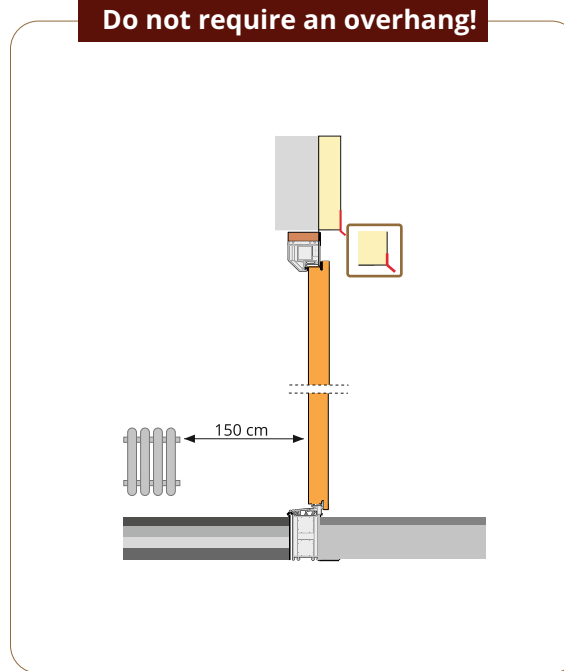

Optimal door and sidelight anchoring points

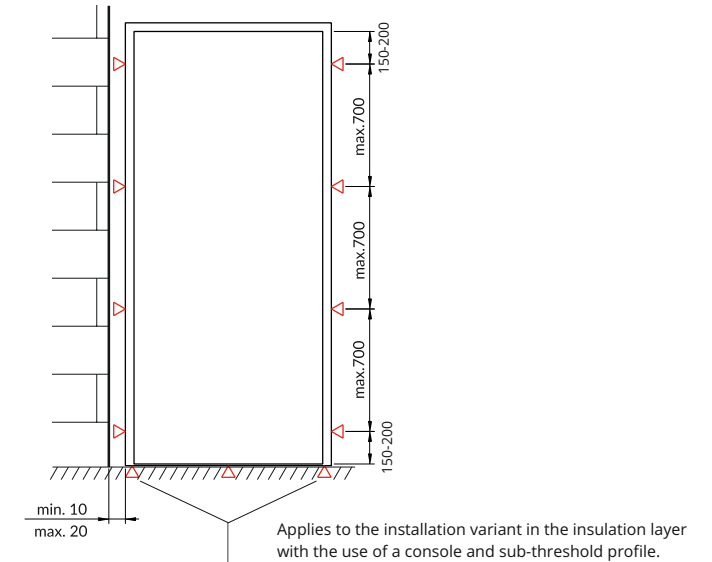

Dedicated installation kits for installing composite doors

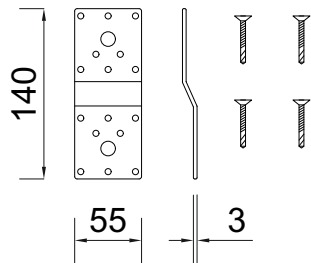

Kit for single-leaf doors
 8 pcs. of bent installation anchors under the frame profile
 32 pcs. of screws 4.2x32

Use only for wider sidelights than 530 mm

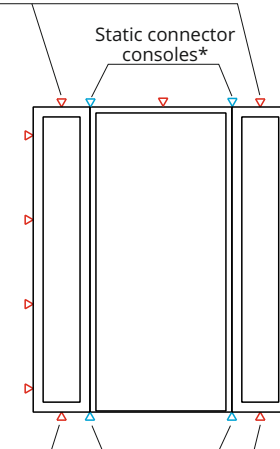

Use only for wider sidelights than 530 mm

Use only for taller sidelights than 530 mm

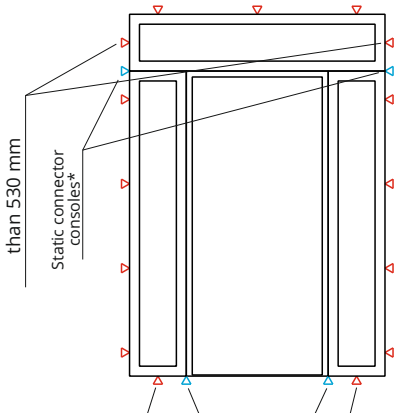

Use only for wider sidelights than 530 mm

*Static connector anchoring consoles are supplied with sidelights.

Recommended composite door installation system

ULTIMATE

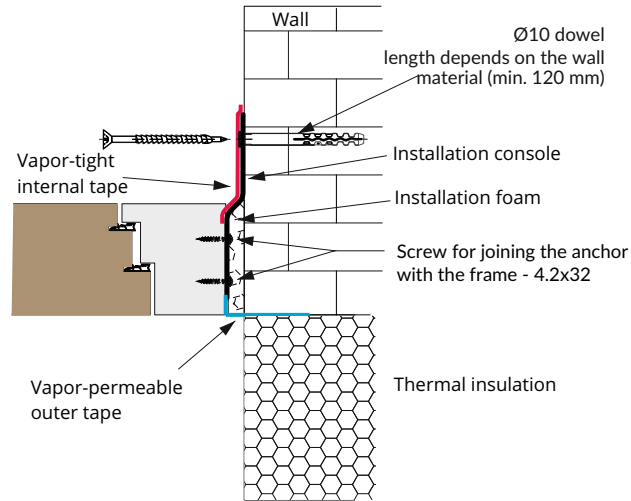

ARCTIC ULTRA, ARCTIC PLUS, ARCTIC oraz TOP

Dedicated for installation in the insulation layer

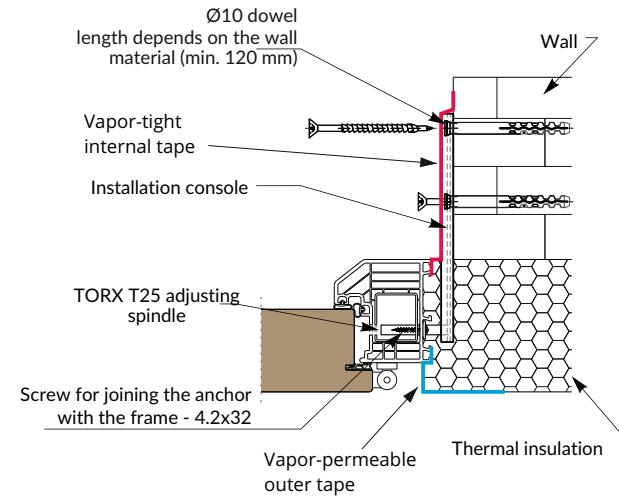

Dedicated for installation in the wall layer using dedicated connectors

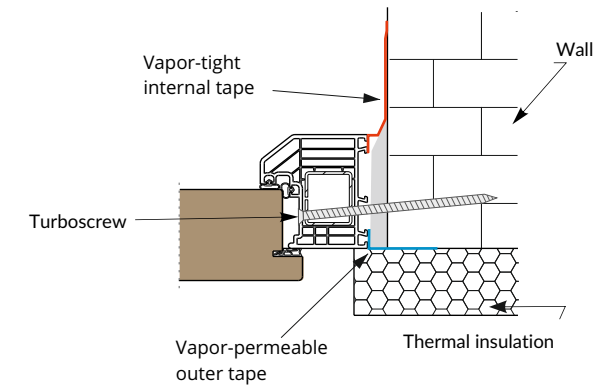

It is recommended to install the door on a sub-threshold profile and perform thermal insulation and waterproofing of the threshold part.

ULTIMATE

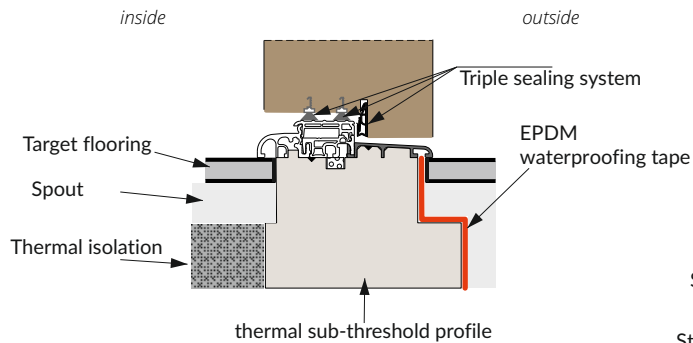

ARCTIC ULTRA, ARCTIC PLUS, ARCTIC, TOP

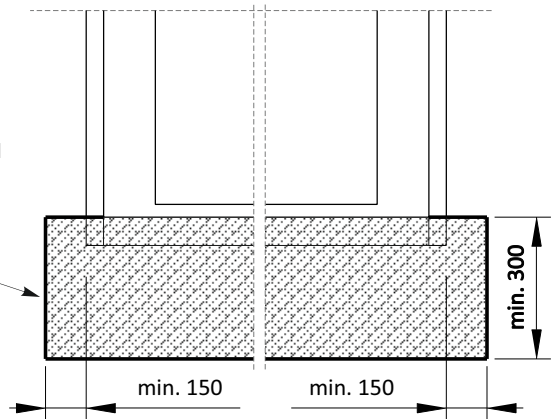
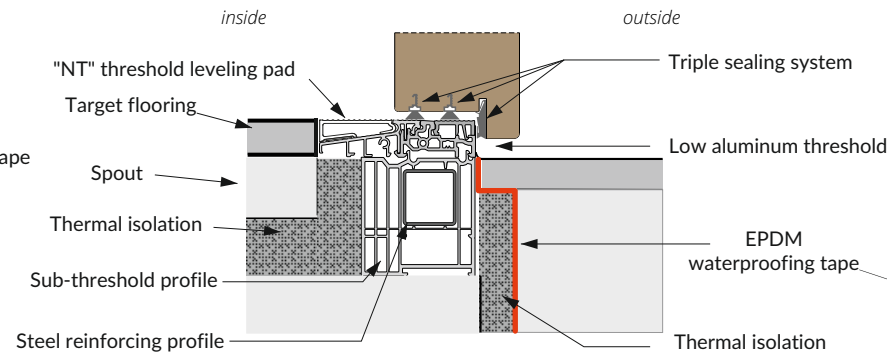

Available sizes of sub-threshold profiles

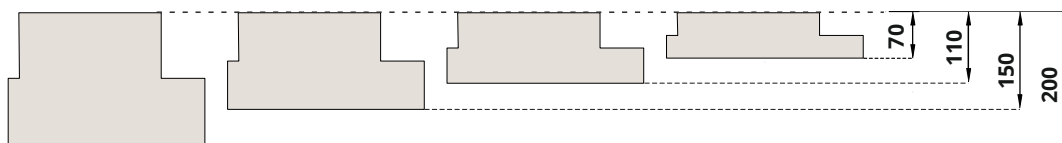

ULTIMATE

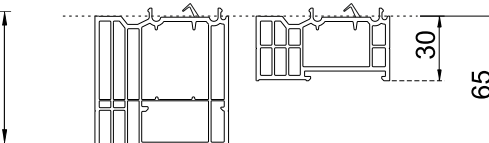

ARCTIC ULTRA, ARCTIC PLUS, ARCTIC, TOP

Sub-threshold profiles can be combined with each other to obtain the required height.

DOOR MAINTENANCE

LIMITED TO MINIMUM

Door maintenance products:

- multifunctional oils and greases
- agents for the maintenance of fittings, metal elements and stainless steel
- seal maintenance products



Winkhaus oil for lubricating fittings
Price*:
7,00 € - 10 ml



Spray for cleaning and maintaining inox
Price*:
15,00 € - 600 ml



Cleaning agent for inox
Price*:
5,00 €- 30 ml

*Not subject to discounts.

In addition, we offer:

1. Components and systems for warm installation of composite doors and Real Wood windows
2. Renovation silicone seal for PVC doors and windows,
3. Retouch, wax and varnishing touch-up systems,
4. Components and spare parts for composite doors and PVC windows,
5. Stained glass products and flat glass products – used in the following industries:
construction, interior finishing, religious, and advertising.

In order to obtain additional information on the optimal selection of doors and accessories, configurations, decorations and stained glass

- please contact our customer service department: wyceny@vikking.eu or tel. +48 519 325 114

RECOMMENDED!



ASYMMETRICAL
SHAPE



Renovation seal for doors and windows
Price*: 1,00 € /mb

- Did you know?
Silicone seals guarantee the highest protection against heat loss for many years and provide above-standard comfort of use when closing the door.

Vikking is the sole producer of energy-saving composite wood doors and Real Wood windows. Our unique solutions are the subject of many applications for international patent protection.
One style, the highest quality and personalized accessories – in one place, from a reliable supplier.

REAL WOOD



ENERGY-SAVING VIKKING WINDOWS

INNOVATIVE DESIGN

INNOVATIVE IDEA

Wooden products are susceptible to many threats resulting from the destructive effect of moisture on the hygroscopic structure of wood. That is why we decorate the surface of PVC profiles to provide them with the aesthetics of precious wood and eliminate the effects and inconveniences resulting from the use of wood.

INNOVATIVE TECHNOLOGY

PVC profiles decorated with Real Wood technology, unlike wood, do not require maintenance against weather conditions. Possible repairs of the structure and varnish coatings are also possible in buildings where windows with the Real Wood surface are installed.

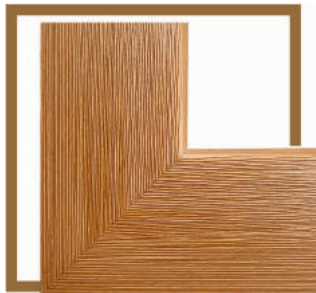

PERFECT TECHNOLOGY

AESTHETICS AND QUALITY

The width of the weld – the place where the window profiles are connected – has a significant impact on the aesthetics of the window. We manufacture Real Wood windows in V-PERFECT technology on lines equipped with state-of-the-art numerically controlled robots to make profile connections stronger, more precise and provide more tightness than traditional welds.



UNIQUE PVC WINDOWS WITH REAL WOOD PROFILES

The unique decoration system created by the VIKKING team of engineers is subject to international patent protection.

The surface decoration of PVC profiles in RW technology eliminates the need for veneering profiles and ensures everlasting durability of the obtained structure.

Real Wood windows, unlike wooden windows, do not require expensive surface maintenance.

The surface of the Real Wood window profiles is very similar to that of noble wood, but without the disadvantages that wood has.

Real Wood decoration and varnishing can be made in any configuration.

Unlike veneered windows, Real Wood windows always have all visible niches varnished in the same color as the outer color of the windows.

PROPRIETARY SOLUTION

DIFFERENT SHAPES AVAILABLE



FILLING OF THE FITTING GROOVE



VARNISHED RECESSES



STRUCTURAL BONDING OF GLAZING

Our proprietary solution of combining traditional glazing with the structural bonding of glazing packages prevents the door leaves from sagging, improves anti-burglary parameters, and increases safety and comfort of use. It also allows to optimize the steel reinforcements of window profiles, which greatly affects protection against the loss of valuable energy. This patented innovative solution is a continuation of our proprietary method of structural bonding of glazing in composite doors.



REVOLUTIONARY AIRING

ENERGY-EFFICIENT AIRING WITHOUT DRAFTS



During airing, the window meets the requirements of the ENV 1627-1630 standard up to class RC2. Therefore, it has the parameters of a closed anti-burglary window.

door leaf sliding function on 6 mm



SMART SLIDE

Sliding terrace doors

SMART-SLIDE sliding doors are a new generation in sliding terrace doors, which are characterized above all by excellent technical properties and comfort of use. Smart-slide sliding doors give the opportunity to create a glass structure with overall dimensions of 5.85 x 2.5 m. Locking around the entire perimeter of the leaf provides high downforce, and when opened, the leaf moves lightly. An innovative closing mechanism allows for simple and intuitive operation.

LIGHTEN UP YOUR LIVING ROOM

SMART SLIDE doors provide not only potential profits and satisfaction with comfort of use, but are also known for their interesting minimalist and slightly Scandinavian design. The non-opening part of permanent glazing implemented in extremely narrow profiles allows for maximizing glazing surfaces and reducing the surface of the frames, which is consistent with customer expectations and trends in the design of modern glazing.



HST

Lift and slide terrace doors

MORE LIGHT

The perfect solution for a comfortable combination of the interior with the terrace and for a panoramic view – thanks to the large glass area in the HST lift-slide door.

AMAZING LIGHTNESS

Special mechanisms allow to move huge door leaves with minimal force. Turning the handle downwards from the closed position raises the leaf by a few millimeters, releases the downforce of the seals and allows to easily move the leaves.

A house without barriers? Of course!
A low threshold in terrace doors.

PSK

Tilt and slide terrace doors

The maximum dimensions of PSK door leaves reach: 1600x2100mm or 1400x2300mm. The advantages of this solution are moderate prices and high tightness. The main benefit of such a solution is the creation of a large glazed surface while maintaining the functionality of the rooms.



Adjust windows to the functionality of the rooms in your home

Together, we will select the best solutions to meet your needs.

VIKKING WINDOWS ARE KNOWN FOR THEIR:

- INNOVATIVE DESIGN
- ENERGY SAVING SOLUTIONS
- DURABILITY FOR GENERATIONS
- COLORS NOT AVAILABLE IN OTHER SYSTEMS
- UNLIMITED CONFIGURATION OF ACCESSORIES
- LEADING COMPONENT SUPPLIERS

We are not afraid of even the most demanding projects!



This price list comes into force on 05/04/2020 and cancels previous offers.

All information contained in this publication has been provided for promotional purposes only and cannot be the subject of a binding commercial offer. The offer is valid from 04/05/2020. On this day all previous offers expire. The individual production process, differences in wood grain, colors and structure of the door surface, as well as the manual creation of stained glass decorations make up the unique character of VIKKING composite doors, any claims in this regard cannot constitute grounds for complaint. Due to printing conditions, the colors and patterns presented may slightly differ from the real ones and cannot be considered binding. The manufacturer reserves the right to technical improvements and product changes. We manufacture and equip all products only based on individual customer orders. Before installing the door, read the instructions for installation, use and maintenance, and the warranty conditions of the door. Failure to comply with the rules contained therein may void the warranty. We make every effort to ensure that our publications contain full and reliable knowledge about the offer, but we are not responsible for any inaccuracies. This publication is fully protected by copyright. Copying, including partial copying, always requires the consent of the manufacturer. We manufacture composite doors and Real Wood windows based on our own proprietary, patented technological solutions. Unlawful infringement of intellectual property will be the basis for claims for damages.